NOVEL HETEROCYCLIC CONSTRUCTIONS MEDIATED BY 1,4-DIPOLAR INTERMEDIATES AND RELATED CHEMISTRY

THESIS SUBMITTED TO THE UNIVERSITY OF KERALA
IN FULFILMENT OF THE REQUIREMENTS FOR THE DEGREE OF
DOCTOR OF PHILOSOPHY
IN CHEMISTRY UNDER THE FACULTY OF SCIENCE

BY
REMA DEVI B.

UNDER THE SUPERVISION OF
Dr. G. VIJAY NAIR



ORGANIC CHEMISTRY SECTION
REGIONAL RESEARCH LABORATORY (CSIR)
THIRUVANANTHAPURAM-695 019
KERALA, INDIA

JULY 2007

Dedicated to My Beloved Grandfather

Sri. GOVINDAPANICKER

DECLARATION

I hereby declare that the matter embodied in the thesis entitled **“NOVEL HETEROCYCLIC CONSTRUCTIONS MEDIATED BY 1,4-DIPOLAR INTERMEDIATES AND RELATED CHEMISTRY”** is the result of the investigations carried out by me at the Organic Chemistry Section of Regional Research Laboratory (CSIR), Trivandrum, under the supervision of **Dr. G. Vijay Nair** and the same has not been submitted elsewhere for any other degree.

Rema Devi B.

Trivandrum

July 2007



REGIONAL RESEARCH LABORATORY (CSIR)
GOVERNMENT OF INDIA
TRIVANDRUM-695 019, INDIA
Telephone: 91-471-2490406; Fax: 91-471-2491712

Dr. G. Vijay Nair, F. A. Sc.
Senior Associate, JNCASR
Organic Chemistry Section

CERTIFICATE

This is to certify that the work embodied in the thesis entitled **“NOVEL HETEROCYCLIC CONSTRUCTIONS MEDIATED BY 1,4-DIPOLAR INTERMEDIATES AND RELATED CHEMISTRY”** has been carried out by **Ms. Rema Devi B.** under my supervision at the Organic Chemistry Section of Regional Research Laboratory (CSIR), Trivandrum, and the same has not been submitted elsewhere for any other degree.

G. Vijay Nair
(Thesis Supervisor)

Trivandrum

July 2007

email: yijaynair_2001@yahoo.com

ACKNOWLEDGEMENTS

I humbly express my gratitude, respect and obligation to my research supervisor **Dr. G. Vijay Nair** for his valuable suggestions, criticism and creative guidance. I am indebted to him for introducing me in the field of research.

I am thankful to Prof. T. K. Chandrashekar, Director, Regional Research Laboratory, for providing all the laboratory facilities to carry out this work.

I wish to record my profound sense of gratitude and indebtedness to **Prof. K. N. G. Unnithan, Prof. K. Sathyadas** and **Prof. K. Sundaresan** for their sincere advice and continuous encouragement during my academic years.

My sincere thanks are also due to

- ❖ Dr. Rajeev S. Menon for encouragement and guidance.
- ❖ Dr. M. V. Nandakumar, Dr. Anu Augustine, Dr. S. Bindu, Dr. Smitha M. Nair, Dr. Sindhu Mathai, Mr. N. Abhilash and Mr. V. Sreekumar for their generous help during different stages of my doctoral studies.
- ❖ Dr. Mangalam S. Nair, Dr. R. Luxmi Varma, Dr. K. V. Radhakrishnan and Dr. P. Shanmugham for their general help.
- ❖ Mrs. Soumini Mathew for recording NMR spectra and Mrs. Viji for elemental analysis.
- ❖ Mrs. Ani Deepthi, Ms. Vidya N. and Ms. Sandhya B. for support and encouragement.
- ❖ All the present and former members of organic chemistry division for their help and cooperation throughout my tenure at RRL.
- ❖ CSIR, New Delhi and DST, Govt. of India for financial assistance.

I wish to express my deep gratitude to all my teachers and friends for their whole-hearted support and encouragement.

Words are inadequate to express my feelings for my parents and sister for their love, support and inspiration.

Rema Devi B.

CONTENTS

Declaration	i
Certificate	ii
Acknowledgements	iii
Preface	vii
Abbreviations	ix

Chapter 1

A Brief Survey of Huisgen 1,4-Dipolar Cycloaddition Reaction	1-26
1.1 Introduction	1
1.2 General Introduction to 1,4-Dipolar Cycloaddition Reactions	1
1.3 The History and Development	3
1.4 Heterocyclic Betaines as 1,4-Dipoles	9
1.4a Bimolecular 1,4-Dipolar Cycloaddition Reaction	9
1.4.b Intramolecular 1,4-Dipolar Cycloaddition Reactions	12
1.5 Formal 1,4-Dipolar Cycloaddition Reactions	14
1.6 Dipolar Cycloaddition Reactions of N-Heterocycles	21
1.7 Present Work	23
1.8 References	24

Chapter 2

Novel One Pot Synthesis of Tetrahydrobenzoquinolizine Derivatives and Oxindolinylidene Derivatives via Huisgen 1,4-Dipolar Cycloaddition Reactions	27-75
2.1 Introduction	27
2.1.1 Multicomponent Reactions (MCRs)	27
2.1.1a The Huisgen 1,4-Dipolar Cycloaddition Reactions of Isoquinoline	28
2.2 Background to the Present Work	31
2.3 Results and Discussion	33
2.3.1 Reaction of Isoquinoline and DMAD with	

	Benzylidenemalononitriles	33
2.3.1.1	Mechanistic Considerations	40
2.3.2	Reaction of Isoquinoline and DMAD with Arylcianoacrylates	41
2.3.3a	Preparation of Isatilidene Derivatives	43
2.3.3b	Reaction of Isoquinoline and DMAD with Isatilidene Derivatives	43
2.3.3c	Mechanistic Considerations	48
2.4	Conclusion	49
2.5	Experimental Details	50
2.6	References	74

Chapter 3

A Facile Synthesis of Pyridobenzothiazole Derivatives via 1,4-Dipolar Cycloaddition Reaction of Benzothiazole-Dimethyl Acetylenedicarboxylate

Zwitterion with Arylidenemalononitriles **76-90**

3.1	Introduction	76
3.2	Background to the Present Work	77
3.3	Statement of the Problem	77
3.4	Results and Discussion	78
3.4a	Reaction of Benzothiazole and DMAD with Arylidenemalononitriles	78
3.5	Mechanistic Considerations	83
3.6	Conclusion	83
3.7	Experimental Details	84
3.8	References	90

Chapter 4

Pyridine Catalyzed Reaction of Dimethyl Acetylenedicarboxylate with Electrophilic Styrenes

91-119

4.1	Introduction	91
4.1.1	Addition of Phosphine	92
4.1.2	Addition of Isocyanides	93

4.1.3	Addition of Nucleophilic Carbenes	94
4.1.3a	Dimethoxycarbene	94
4.1.3b	N-Heterocyclic Carbenes (NHCs)	95
4.1.4	Addition of Pyridine and Related Species	95
4.2	Statement of the Problem	99
4.3	Results and Discussion	100
4.3.1	Reaction of Pyridine and DMAD with Activated Styrenes	100
4.3.2	Mechanistic Considerations	
	107	
4.4	Conclusion	107
4.5	Experimental Details	108
4.6	References	118
	Summary	120
	List of Publications	123

PREFACE

Heterocyclic compounds are important in organic chemistry due to their wide ranging applications. Among the methods available for their synthesis, the dipolar cycloaddition reactions, especially 1,3-dipolar cycloaddition reactions have attracted much attention. In comparison to the well exploited 1,3-dipolar cycloaddition reaction, the synthetic utility of the 1,4-dipolar cycloaddition remained underexploited. The potential value of the 1,4-dipolar cycloaddition reactions rests mainly on the fact that a single synthetic scheme can give access to many six-membered heterocycles. The reactions generally occur under mild conditions without the need of catalysts.

Even though a variety of cycloaddition reactions are known, the 1,4-dipole based cycloaddition reactions, for the construction of six membered heterocycles, are relatively few. For this reason, it seemed desirable to explore the utility of cycloadditions in synthetic organic chemistry. A detailed investigation of the reactivity of 1,4-dipoles derived from nitrogen containing nucleophiles has been carried out and the results obtained are presented in this thesis entitled ***“NOVEL HETEROCYCLIC CONSTRUCTIONS MEDIATED BY 1,4-DIPOLAR INTERMEDIATES AND RELATED CHEMISTRY”***. The main objective of the present study was to design novel heterocyclic systems, based on 1,4-dipolar intermediates which are usually generated *in situ* from various nitrogen containing nucleophiles and dimethyl acetylenedicarboxylate (DMAD). The thesis is divided into four chapters. Relevant references are given at the end of each chapter.

The first chapter presents a brief survey of 1,4-dipolar cycloaddition reactions. A definition of the present research problem is provided at the end of this chapter.

The second chapter describes the reactivity of 1,4-dipolar intermediate generated from isoquinoline and DMAD with activated styrenes and isatylidene derivatives resulting in the facile synthesis of tetrahydrobenzoquinolizine and oxindolinylidene derivatives.

In the third chapter, the interception of the 1:1 zwitterionic intermediate, generated in situ from benzothiazole and DMAD with activated styrenes is described. It was found that the in situ generated 1:1 intermediate undergoes a facile addition with arylidenemalononitrile to afford the diastereomeric mixtures of pyridobenzothiazole derivatives.

The fourth chapter contains the results of our investigations on the catalytic reactivity of pyridine with DMAD and arylidenemalononitriles leading to the facile synthesis of highly substituted trans-butadiene derivatives.

It may be mentioned that each chapter of the thesis is presented as an independent unit and therefore the structural formulae, schemes and figures are numbered chapter-wise.

A summary of the work is given towards the end of the thesis.

ABBREVIATIONS

Ar	:	argon
Cy	:	cyclohexyl
DCM	:	dichloromethane
d	:	doublet
DMAD	:	dimethyl acetylenedicarboxylate
DME	:	dimethoxy ethane
DMF	:	<i>N, N</i> -dimethylformamide
DMSO	:	dimethyl sulfoxide
Et	:	ethyl
EWG	:	electron-withdrawing group
HRMS	:	high resolution mass spectra
Hz	:	hertz
IR	:	infrared
<i>J</i>	:	coupling constant
m	:	multiplet
Me	:	methyl
mg	:	milligram
mL	:	milliliter
Mp	:	melting point
NHC	:	<i>N</i> -heterocyclic carbene
NMR	:	nuclear magnetic resonance
Nu	:	nucleophile
Ph	:	phenyl
ppm	:	parts per million
Pr	:	propyl
Py	:	pyridine

rt	:	room temperature
s	:	singlet
t	:	triplet
<i>tert</i>	:	tertiary
THF	:	tetrahydrofuran
TLC	:	thin layer chromatography
TPP	:	triphenylphosphine
TMS	:	trimethylsilyl

A Brief Survey of Huisgen 1,4-Dipolar Cycloaddition Reaction

1.1 Introduction

The focal theme of the thesis is the generation of 1,4-dipoles (zwitterions) by the reaction of *N*-heterocyclic compounds with activated acetylene and the interception of these dipoles with various dipolarophiles, thus constituting 1,4-dipolar cycloadditions. As an introduction to the present work, a brief survey of various 1,4-dipolar cycloaddition reactions is presented in this chapter.

1.2 General Introduction to 1,4-Dipolar Cycloaddition Reactions

The concept of cycloaddition reaction was first introduced by Diels and Alder,¹ when they observed the formation of six membered rings with the participation of [4+2] π electrons. Generally, cycloaddition reactions are considered to be concerted processes with the simultaneous formation of two new σ -bonds, *via* a cyclic transition state.

Even though a variety of cycloaddition reactions are known, the 1,4-dipole based cycloaddition reactions are relatively few. The seminal work of Huisgen has contributed mainly to the development of this interesting area of chemistry.² The potential value of 1,4-dipolar cycloadditions rests mainly on the fact that a single synthetic scheme can give access to many six-membered heterocycles. The reactions generally occur under mild conditions without the need of catalysts.

The existence of 1,4-dipoles was conclusively established by Huisgen nearly five decades ago. A 1,4-dipole is defined as a system 'a-b-c-d', in which 'a' has an

unfilled electron shell and carries a formal positive charge and 'd' is an anionic center with a free electron pair. The 1,4-dipole thus generated usually contains one or more heteroatoms. It is only the internal octet stabilization with the help of a lone pair on 'b' that makes the 1,4-dipole capable of existence (Scheme 1.1).

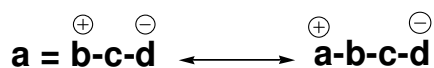

Scheme 1.1

The general principle of 1,4-dipolar cycloaddition is distinctly different from the concerted pathway of Diels-Alder reaction and occurs through a two-step addition mechanism in which the two new σ -bonds are formed one after the other (Scheme 1.2).

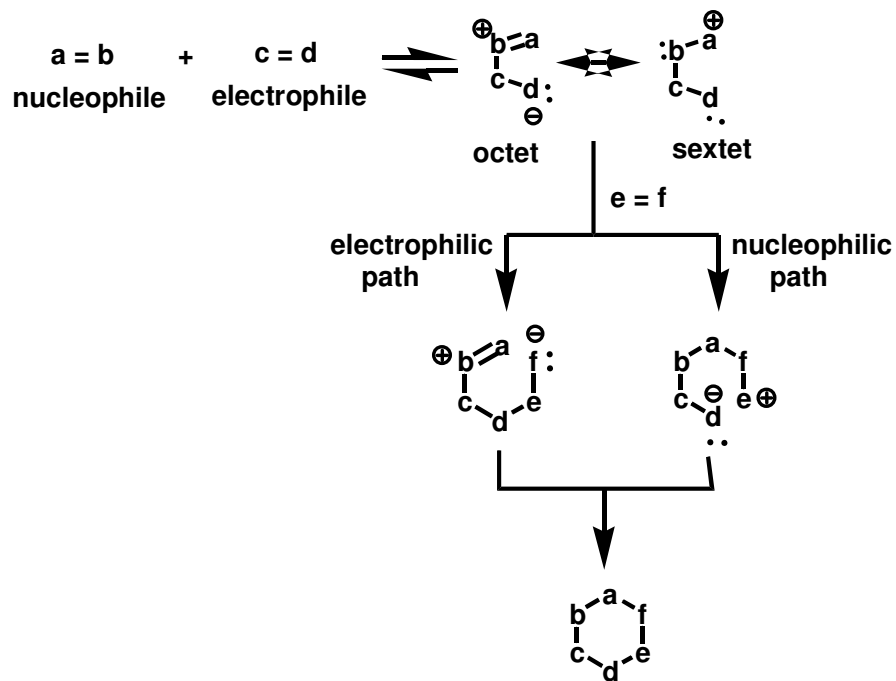

Scheme 1.2

In most cases studied, the 1,4-dipole is not isolable. The dipolarophile can be electrophilic or nucleophilic multiple bond systems.

1.3 The History and Development

Many observations in the literature can be interpreted as 1,4-dipolar cycloaddition reactions, the first one was observed 160 years ago by Regnault, when “carbonyl sulfate” **3**, was obtained from the reaction of ethylene **1** and sulfur trioxide (Scheme 1.3).³

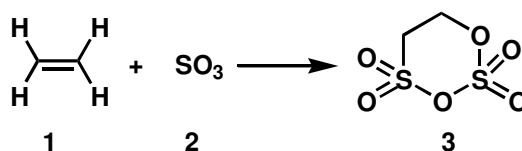

Scheme 1.3

Aromatic alkenes like styrene **4** when treated with sulfur trioxide, the dipolar cycloaddition reaction occurred to afford the corresponding cycloadduct **5**. Similar reactivity was observed when benzonitrile **6** was treated with SO_3 (Scheme 1.4).⁴

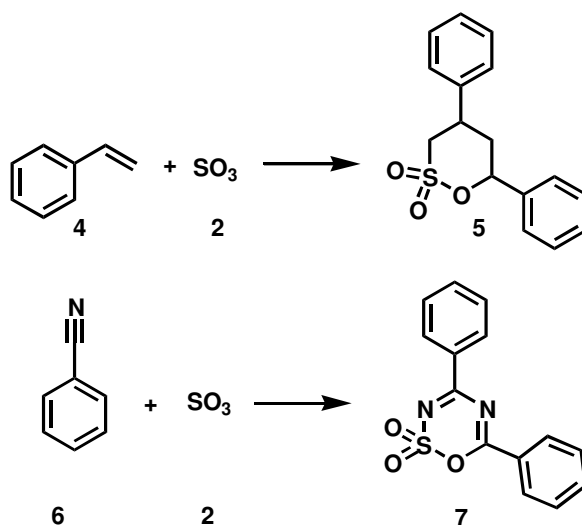

Scheme 1.4

Since 1,4-dipole is not isolable, they are generated *in situ* by the reaction of a nucleophile with an electrophilic double bond system. An exception is the formation of crystalline adduct **9** reported by Huisgen in 1969, by the reaction of *N*-benzylidene-methylamine **8** and sulfur trioxide (Scheme 1.5).^{2a}



Scheme 1.5

Later, Breslow showed that the addition of electron-rich ethyl vinyl ether **10** to the [1,4]-dipole **9** and the subsequent loss of ethanol afforded the product **11** (Scheme 1.6).⁵

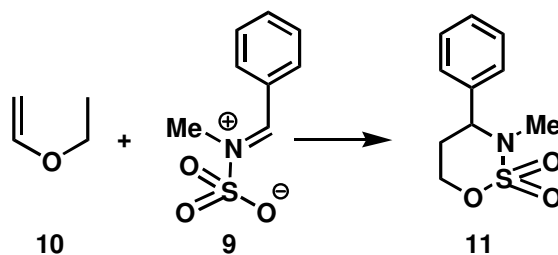

Scheme 1.6

From the scattered observations in the literature, the distinct scheme of 1,4-dipolar cycloaddition reaction emerged in the early 1960s by the pioneering work of Huisgen.^{2,6} One of the oldest examples of 1,4-dipolar cycloaddition reaction was reported by Huisgen in 1965. He has shown that the 1,4-dipole generated from aldimine **8** and dimethyl acetylenedicarboxylate (DMAD) undergoes a 1,4-dipolar

cycloaddition with a second molecule of DMAD to afford the cycloadduct **14** (Scheme 1.7).⁷

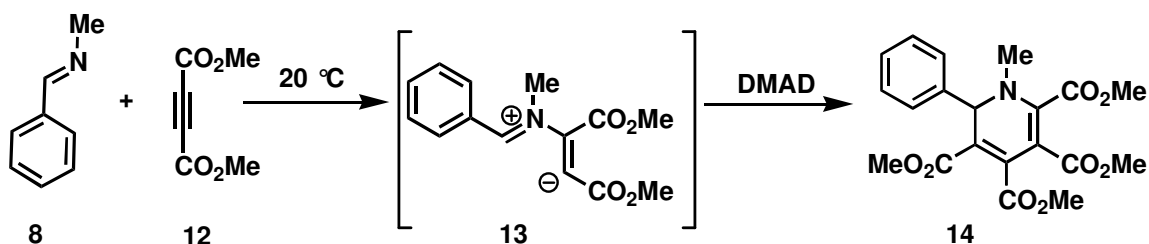

Scheme 1.7

Another interesting observation was that the addition of ketimine **15** to DMAD resulted in an intramolecular proton abstraction to form the corresponding product **17** (Scheme 1.8).⁷

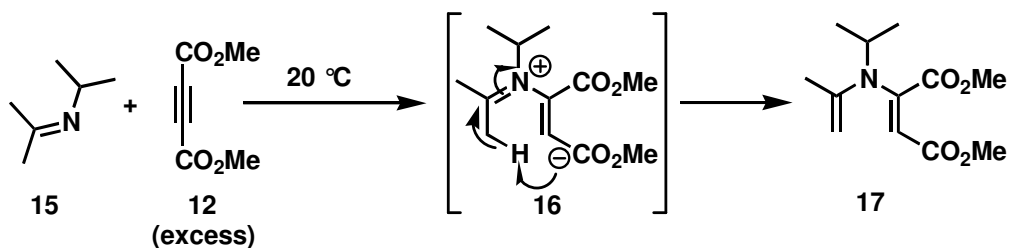

Scheme 1.8

Butler *et al.* reported the reactivity of the 1,4-dipolar species **19** generated from enol ether **10** and 4-phenyl-1,2,4-triazoline-3,5-dione (PTAD) **18**.^{8,9} It was shown that a stabilized 1,4-dipole can add to the weakly dipolarophilic carbonyl group of acetone to form the tetrahydro-oxadiazine **20** (Scheme 1.9).

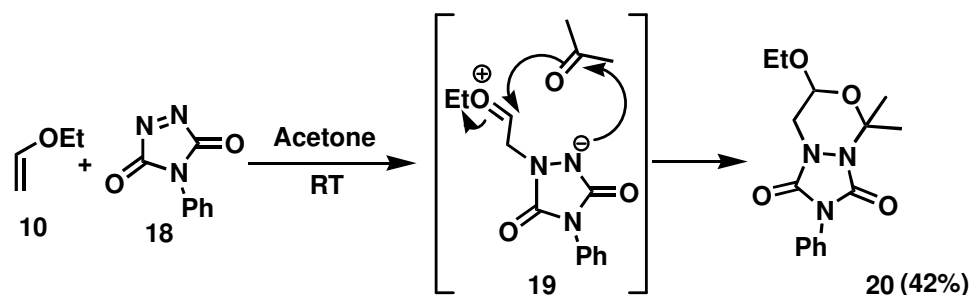

Scheme 1.9

The evidence for a similar 1,4-dipolar intermediate **22** in the reaction of PTAD **18** with 1-phenyl-4-vinylpyrazole **21** was provided by its trapping with acetone, affording tetrahydro-oxadiazine **23** (Scheme 1.10).¹⁰

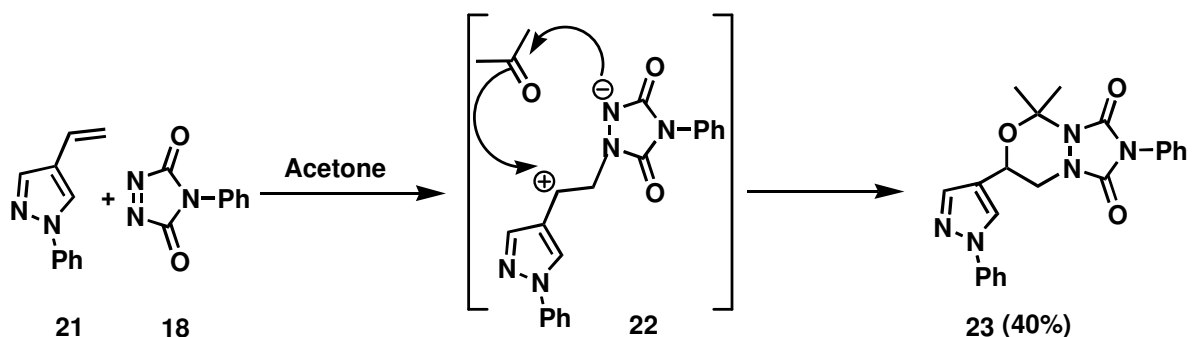

Scheme 1.10

Ghosez *et al.* have reported an interesting intramolecular cyclization of the 1,4-dipole **26** derived from ynamine **24** and N-phenylketenimine **25** resulting in a one pot synthesis of 4-aminoquinoline derivative **28** in good yield (Scheme 1.11).¹¹

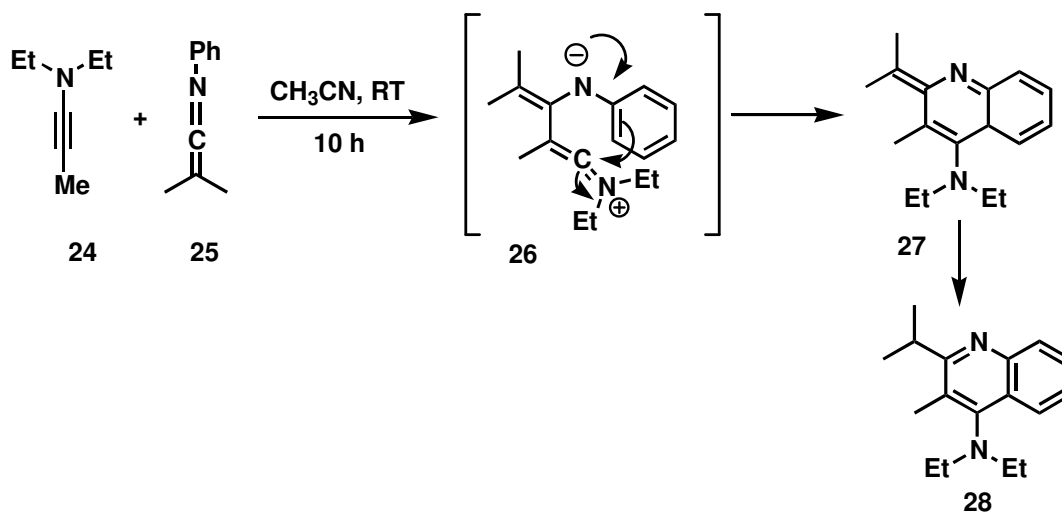

Scheme 1.11

The thermal cycloaddition reaction of highly reactive azirines with heterocumulenes generally proceeds through a 1,4-dipolar intermediate, further reaction of which depends on the stability of the 1,4-dipole thus formed.¹² Schaumann *et al.* have shown that the 1,4-dipole **31** derived from the reaction of 2,2-dialkyl aminoazirine **29** with phenyl isocyanate **30**, adds to another molecule of phenyl isocyanate to afford the cycloadduct hexahydro-s-triazine **32** (Scheme 1.12).¹³

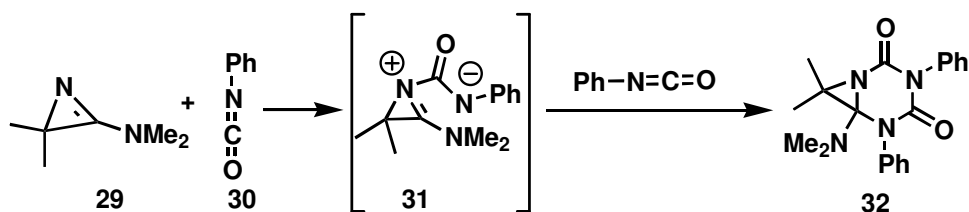

Scheme 1.12

The [2+2] cycloaddition reaction of enol ether **10** with tetracyanoethylene **33**, leading to cyclobutane **36** has been extensively studied by Huisgen and coworkers.¹⁴

This reaction essentially proceeds through a 1,4-dipolar species **34** which in aprotic media undergoes ring closure to cyclobutane **36**, while in protic solvent it affords a 1:1:1 adduct **35** (Scheme 1.13).¹⁵

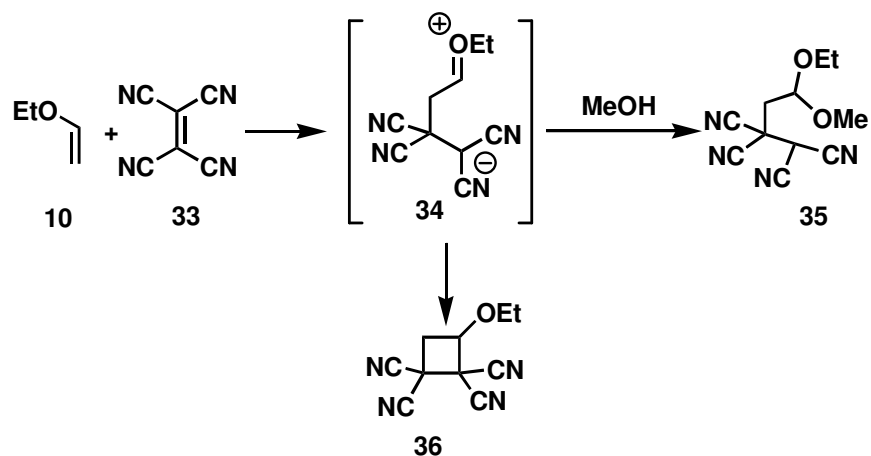

Scheme 1.13

Recently, Machiguchi *et al.* have shown that the reaction between bis(trifluoromethyl)ketene **37** and ethyl vinyl ether **10**, leads to an initial adduct, α -methyleneoxetane **38** by the [2+2] cycloaddition across the ketene carbonyl group. This intermediate then undergoes a ring cleavage to produce a [1,4]-dipole **39**, which is then converted to the final cycloaddition product, cyclobutanone **40** and also an open chain product α,β -enone **41** (Scheme 1.14).¹⁶

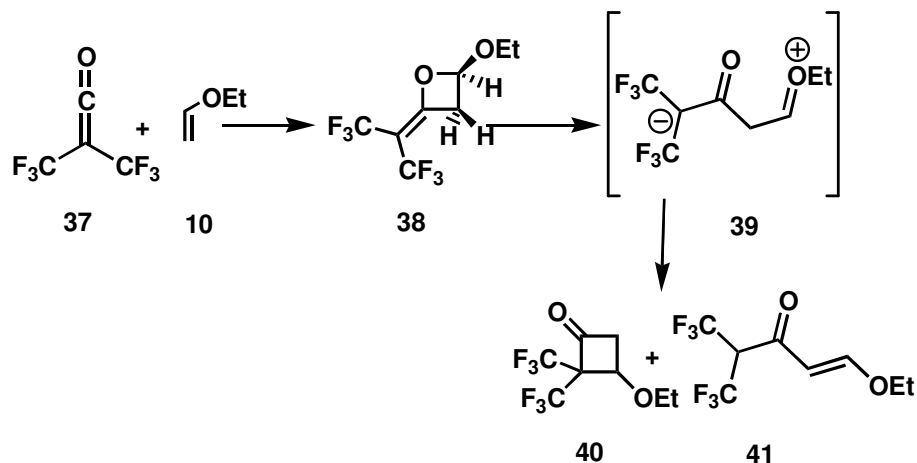

Scheme 1.14

1.4 Heterocyclic Betaines as 1,4-Dipoles

1.4a Bimolecular 1,4-Dipolar Cycloaddition Reaction

The limited utilization of 1,4-dipolar cycloaddition reaction is mainly associated with the difficulty encountered in the generation, stabilization and the reactivity of 1,4-dipoles. Despite these limitations, the applications of mesoionic compounds endowed with a “masked” 1,4-dipole have proved to be an important development in the field of 1,4-dipolar cycloaddition reactions. The cyclocondensation reaction of an appropriately substituted monotropic amidine or thioamide with a 1,3-bielectrophile derived from malonic acid,¹⁷ will lead to mesoionic compounds. These heterocyclic betaines are capable of undergoing cycloaddition with π -bonds (Figure 1.1).

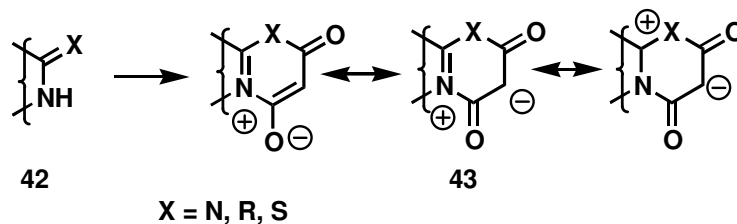
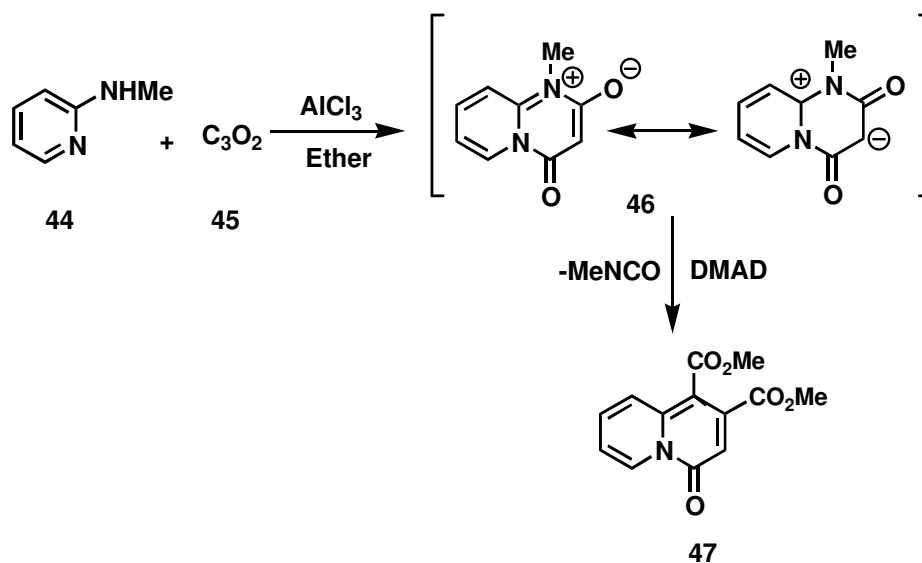

Figure 1.1

An important development in the area of mesoionic compounds is the report by Potts in 1971 on the synthesis of 4*H*-quinolizinone **47** by the bimolecular 1,4-dipolar cycloaddition reaction of heterocyclic betaine **46**, prepared from 2-*N*-methylaminopyridine **44** and carbon suboxide **45**, with DMAD (Scheme 1.15).¹⁸



Scheme 1.15

Gotthardt *et al.* have reported the behavior of pyrimidinium-4-olate **50** as 1,4-dipole in the bimolecular as well as intramolecular 1,4-dipolar cycloaddition reactions.¹⁹ It has been shown that the pyrimidinium-4-olate prepared from amidine **48** and malonate **49**, adds to 1,2,4-triazoline-3,5-dione **18** to afford the [4+2] cycloadduct **52** in high yield (Scheme 1.16).²⁰

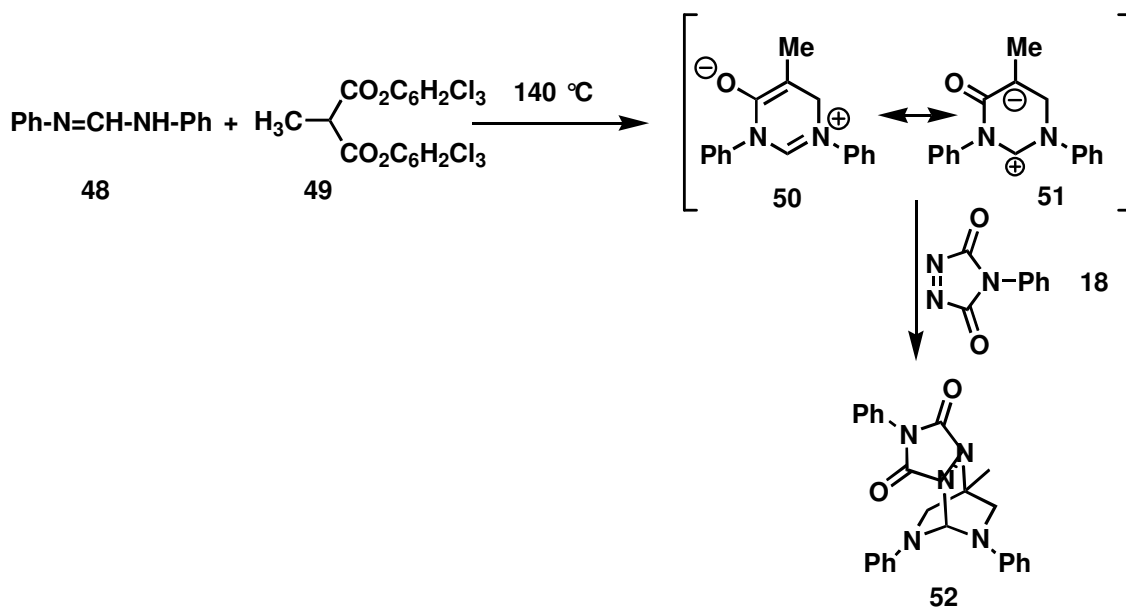

Scheme 1.16

An easy access to highly substituted bicyclic α -pyridone **54** was developed by Padwa and coworkers utilizing the bimolecular 1,4-dipolar cycloaddition strategy. The reaction of bicyclic anhydro-2-oxo-4-hydroxy-1,3-thiazinium hydroxide **53** with electron rich π -systems such as ynamine **24** afforded the [4+2] cycloadduct, which on heating extruded carbonyl sulfide producing substituted α -pyridone **54** (Scheme 1.17).²¹

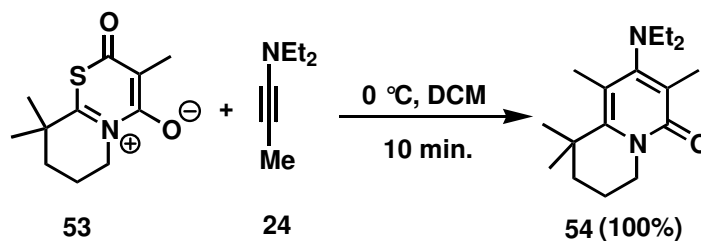

Scheme 1.17

1.4b Intramolecular 1,4-Dipolar Cycloaddition Reactions

Although a few examples of bimolecular cycloaddition have been reported in the literature, little is known about the intramolecular 1,4-dipolar cycloaddition reactions. Potts *et al.* have shown that the anhydro-1,3-oxazinium betaine **57**, generated *in situ*, undergoes intramolecular 1,4-dipolar cycloaddition to give a cycloadduct, which on heating eliminates CO₂ to afford chromeno[4,3-b]pyridine-2-one **58** (Scheme 1.18).²²

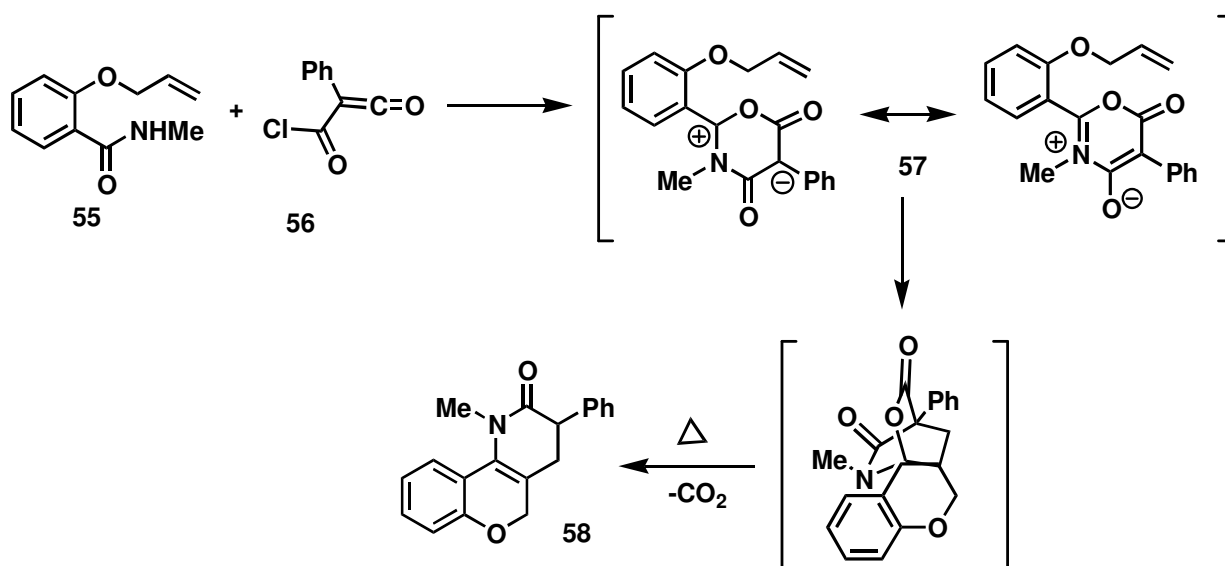

Scheme 1.18

Padwa *et al.* have shown that TMSOTf promoted intramolecular 1,4-dipolar cycloaddition of N-acetoacetylated alkenyl amide **59** offered a convenient route for the synthesis of polycyclic frame work *via* the [4+2] annulation strategy. The reaction proceeds through a cross-conjugated heteroaromatic betaine intermediate **60**, which undergoes intramolecular addition across the C=C bond of the pendant alkene, resulting in the stereoselective formation of the cycloadduct **61** (Scheme 1.19).²³

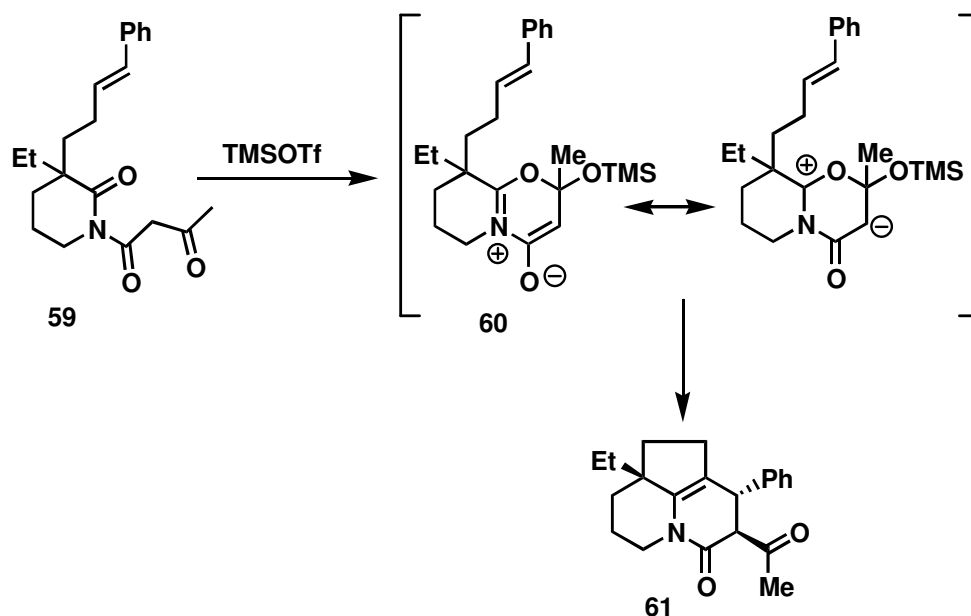

Scheme 1.19

The intramolecular 1,4-dipolar cycloaddition reaction was elegantly employed by Padwa *et al.* in the synthesis of epi-eburnamenine alkaloids. The cycloaddition of *in situ* generated betaine **63** across a tethered indole π -bond, afforded the [4+2] cycloadduct, which was easily converted to epi-16,17-dihydroeburnamenine **64** (Scheme 1.20).²⁴

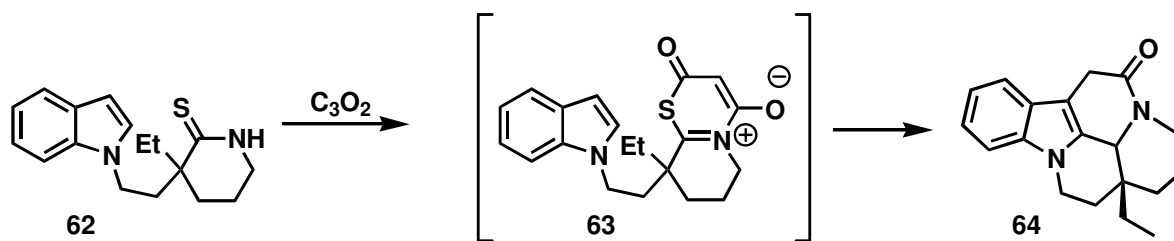

Scheme 1.20

1.5 Formal 1,4-Dipolar Cycloaddition Reactions

The limited synthetic utilization of 1,4-dipolar cycloaddition reaction for the construction of six membered heterocyclic compounds is mainly due to the instability of the *in situ* generated intermediates and their poor performance with weak electrophilic systems. Despite these limitations, during the last few years, lot of work has been devoted to this interesting area to design the synthesis of new heterocyclic compounds. A number of reagents such as *o*-phenyl substituted diesters,²⁵ phthalide sulphones,²⁶ phthalides,²⁷ cyanophthalides²⁸ and *o*-tolyl carboxylates²⁹ have been used as 1,4-dipole synthons. It is now generally accepted that this 1,4-dipolar cycloaddition provides a unique and facile method for the construction of polycyclic systems and it has been used as the key step in the synthesis of several natural products.

Interestingly, Mann *et al.* have observed that N-tosyl-2-phenylazetidone **65**, in presence of BF₃.OEt₂, reacts as a formal 1,4-dipole **66** with various activated and non-activated alkenes. Thus the reaction of **65** with dihydropyran **72** afforded the [4+2] adduct **73** as the major product, whereas with cyclohexene it gave a [4+1] adduct **71**; with allylsilane **67** as the trapping agent the allylated product **68** was obtained as the major product along with minor amounts of the [4+2] adduct **69** (Scheme 1.21).³⁰

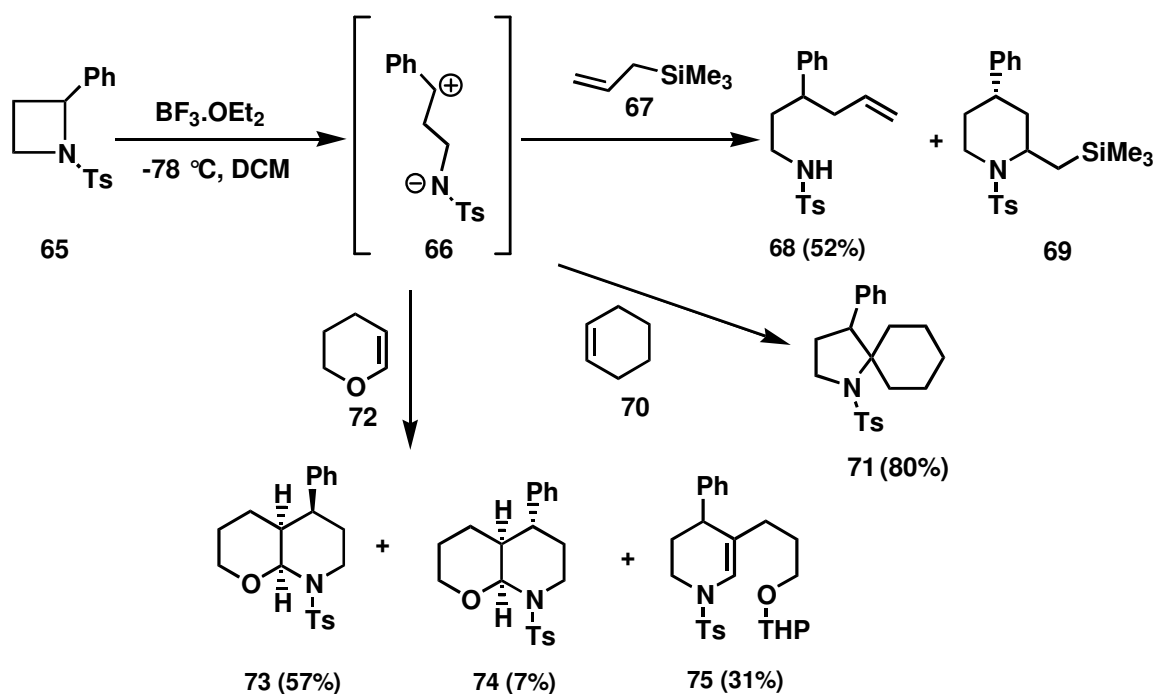

Scheme 1.21

Recently it was shown that a formal [2+2] cycloaddition reaction of 2-phenyl-N-tosyl azetidine **65** with nitrile **76** in presence of $\text{BF}_3 \cdot \text{OEt}_2$ led to the synthesis of tetrahydropyrimidine **79**. It was proposed that the reaction occurs *via* a Ritter process (Scheme 1.22).³¹

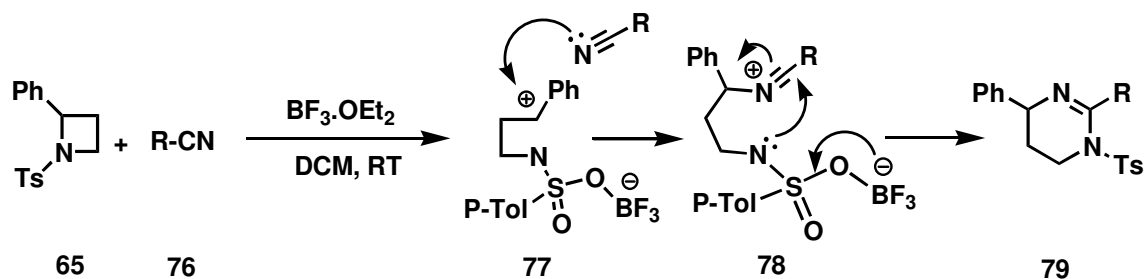

Scheme 1.22

Swenton *et al.* have employed benzocyclobutenedione monoketal **80** as a 1,4-equivalent in the synthesis of (+/-)-4-demethoxydaunomycinone **83**. The key step in the synthesis involves the base induced [4+2] annulation of bromoderivative **82** with the 1,4-dipole equivalent **81** (Scheme 1.23).³²

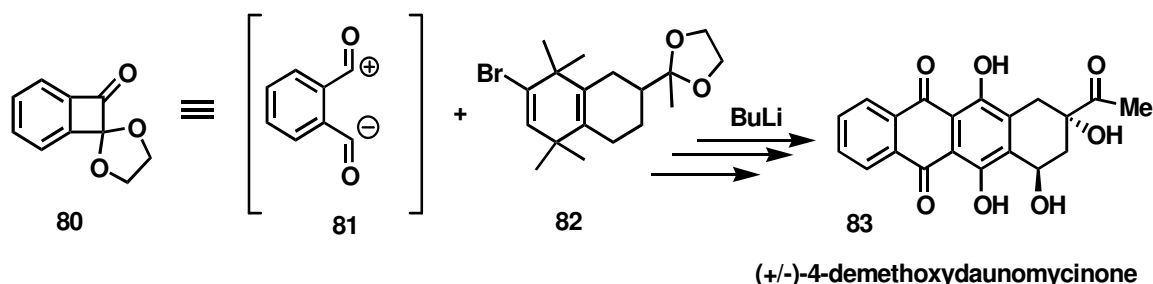

Scheme 1.23

Based on the formal 1,4-dipolar cycloaddition strategy, Biehl *et al.* have developed an efficient synthesis of substituted acridones. The reaction of N-methyl ethylantranilate **84**, as the 1,4-dipole equivalent, with benzyne **86** afforded the [4+2] cycloadduct **87** in good yields (Scheme 1.24).³³

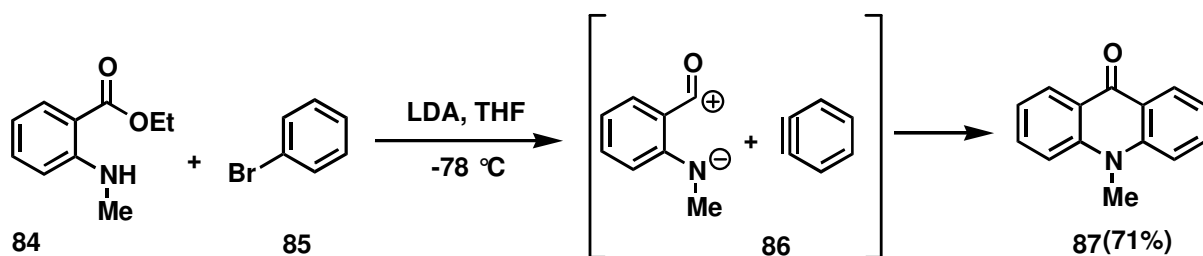

Scheme 1.24

A two step 1,4-dipolar cycloaddition has been utilized as the key step in the total synthesis of antitumor antibiotic (+/-) Fredericamycin A by Bach and coworkers. The coupling of the fragment **88** with the lithio anion of the lactone **89**, followed by

cyclization of the Michael adduct and demethylation afforded (+/-) Fredericamycin A (Scheme 1.25).³⁴

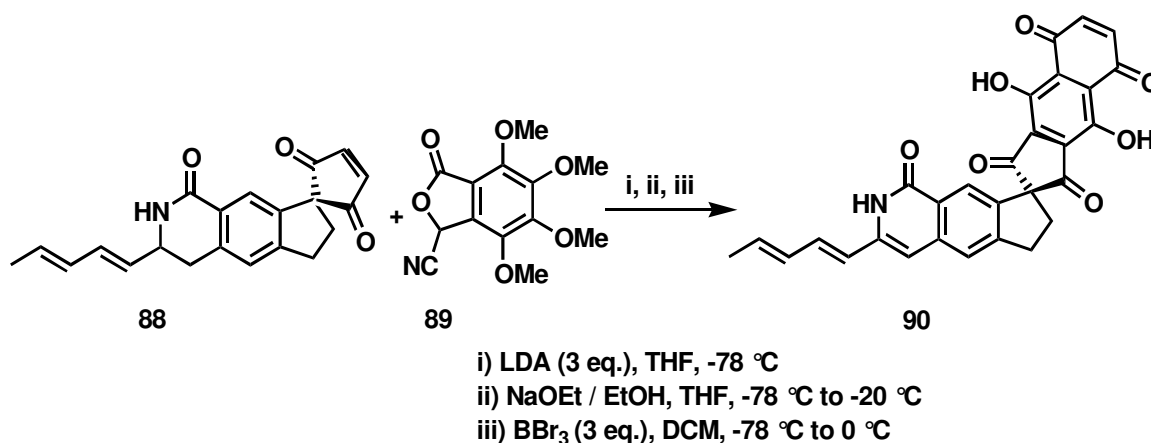

Scheme 1.25

Vinyl isocyanates are readily available, reactive species that can serve as useful 1,4-dipole equivalents in a wide range of cyclization processes. In combination with various electron rich 1,2-dipoles, they can deliver structurally elaborate six-membered nitrogen heterocycles suitable for conversion into a number of alkaloid targets including benzophenanthridines, phenanthridines as well as pyridone-derived systems (Figure 1.2).

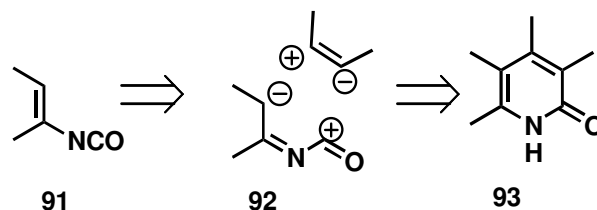
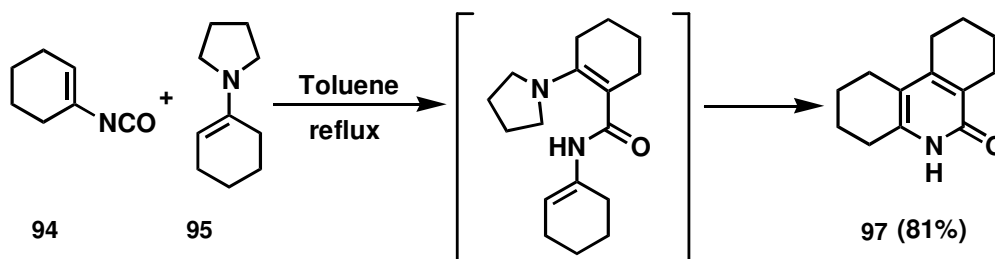

Figure 1.2

Extensive investigations by Rigby and coworkers in this area have produced some interesting results. In one of their earlier reports it was shown that the reaction of

vinyl isocyanate **94** with enamine **95** provided a facile entry into pyridone heterocycle **97** via the intermediate **96** (Scheme 1.26).³⁵



Scheme 1.26

The [4+2] annulation strategy using vinyl isocyanate was successfully employed in the synthesis of benzophenanthridine alkaloid N-nornitidine **100**. The key step involves the cycloaddition of vinyl isocyanate **99** with benzyne generated *in situ* by oxidative decomposition of N-aminobenzotriazole **98** (Scheme 1.27).³⁶

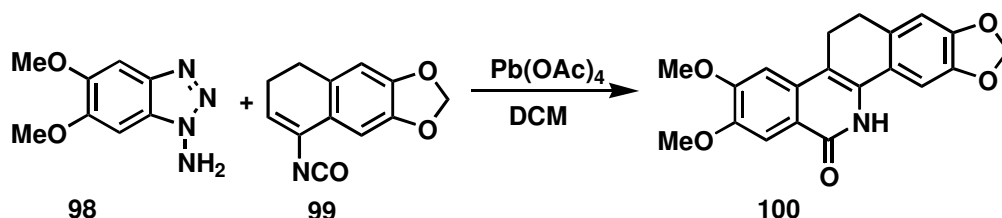

Scheme 1.27

A powerful strategy for the construction of five membered heterocycles was also developed by Rigby utilizing a [4+1] annulation reaction of vinyl isocyanates with 1,1-dipole equivalents. Thus, a reaction of vinyl isocyanate **94** with cyclohexylisocyanide **101** at room temperature afforded the corresponding hydroindolone **103** in excellent yield, which was isolated by simple filtration from the reaction mixture (Scheme 1.28).³⁷

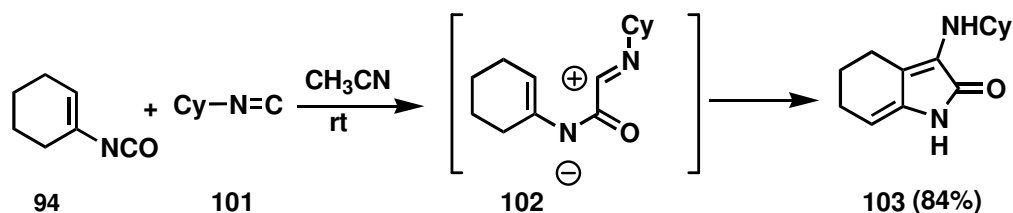

Scheme 1.28

The successful introduction of nucleophilic carbenes as a 1,1-dipole equivalent in these [4+1] annulation reaction was also made by Rigby who demonstrated that the reaction of vinyl isocyanate **94** with dimethoxy carbene, generated by the thermolysis of excess of 2,2-dimethoxy- Δ^3 -1,3,4-oxadiazoline **104**, afforded a good yield of the desired hydroindolone **106** (Scheme 1.29).³⁸

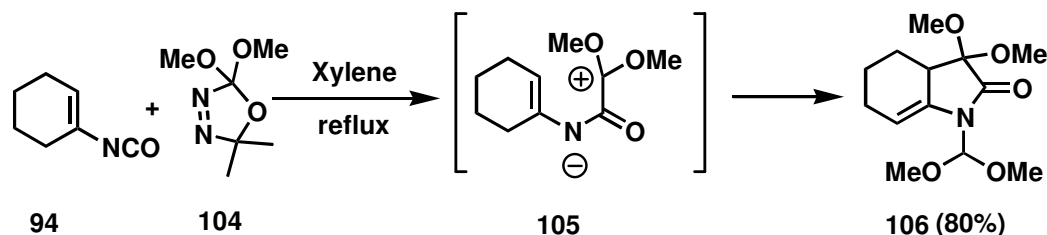

Scheme 1.29

Aliphatic diazo compounds serve as powerful 1,3-dipoles in their reaction with various dipolarophiles leading to a variety of heterocycles.³⁹ An interesting reaction was observed by Regitz and coworkers; phosphinodiazalkene **107** when treated with electron-deficient alkynes such as DMAD, underwent a [4+2] cycloaddition resulting in the formation of novel 1,2,4- λ^5 -diazaphosphine **109**. The reaction proceeds by the initial nucleophilic attack of phosphine to electron deficient carbon of DMAD to form a dipolar intermediate **108**, which then cyclized to give the adduct (Scheme 1.30).⁴⁰

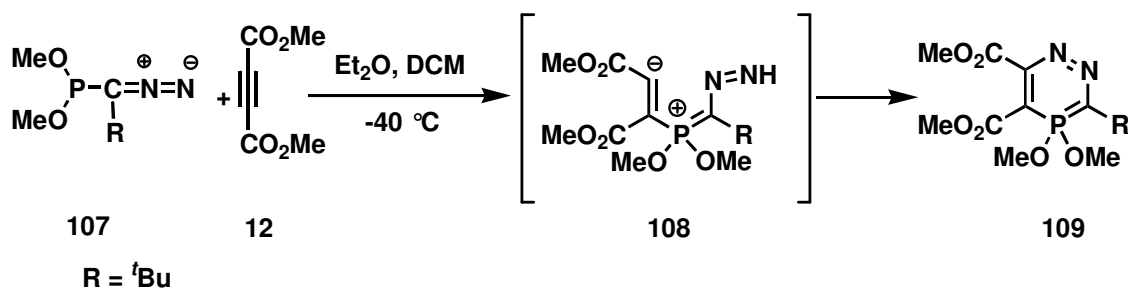

Scheme 1.30

Investigations by Bertrand and coworkers have also shown that bis(diisopropylamino)phosphanylazide **110** can similarly act as a formal 1,4-dipole in its reaction with DMAD, affording the [4+2] cycloadduct **111** in good yield (Scheme 1.31).⁴¹

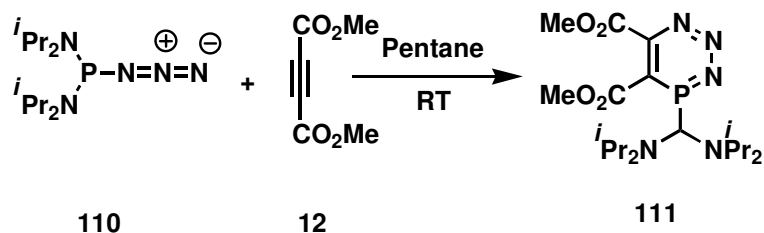

Scheme 1.31

Recently, Niecke and coworkers have found that 4-methylene-6-phosphabicyclo[1.1.0]hex-2-ene **112a** can act as a formal 1,4-dipole in its reaction with diethylazodicarboxylate **113**, affording the [4+2] cycloadduct **114** in excellent yield. The bicyclic phosphorus compound can be represented a dipolar species with a carbon nucleophilic center **112b** (Scheme 1.32).⁴²

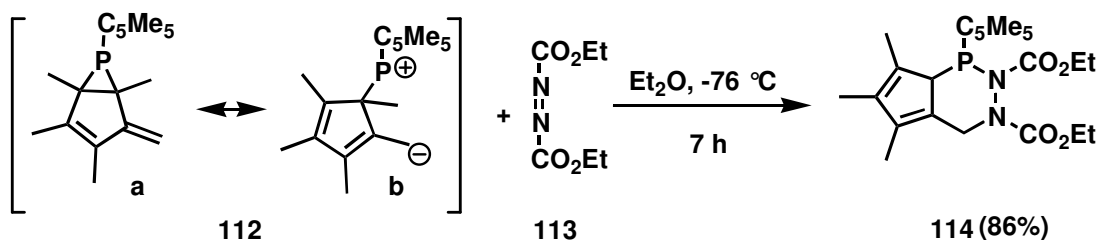

Scheme 1.32

1.6 Dipolar Cycloaddition Reactions of N-Heterocycles

In 1932, Diels and Alder reacted pyridine with DMAD to get a product of unknown structure.⁴³ The structure of this product was established, as 4*H*-quinolizine **117**, much later by the systematic study of Acheson and coworkers.⁴⁴ Subsequent work by Huisgen led to the discovery of the *in situ* generation of the 1,4-dipole **116** in this reaction (Scheme 1.33).

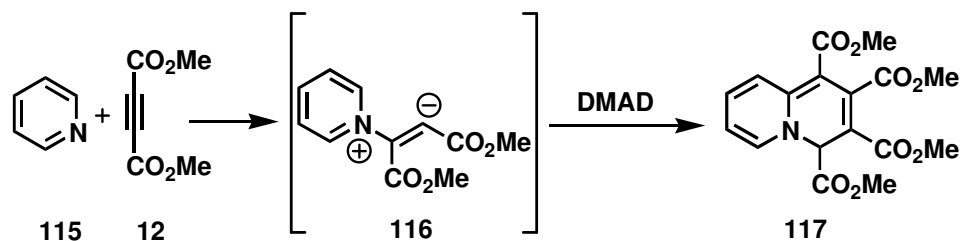

Scheme 1.33

Further investigations by Huisgen on the interception of this 1,4-dipole **116** with excess of phenyl isocyanate afforded pyrimidindione *albeit* only in 25% yield. The reaction proceeds through an initial 1,5-dipole **118** which adds to another molecule of phenyl isocyanate to form a 1,7-dipole **119** which subsequently undergoes a ring closure to form pyrimidindione **120** with the elimination of pyridine (Scheme 1.34).⁴⁵

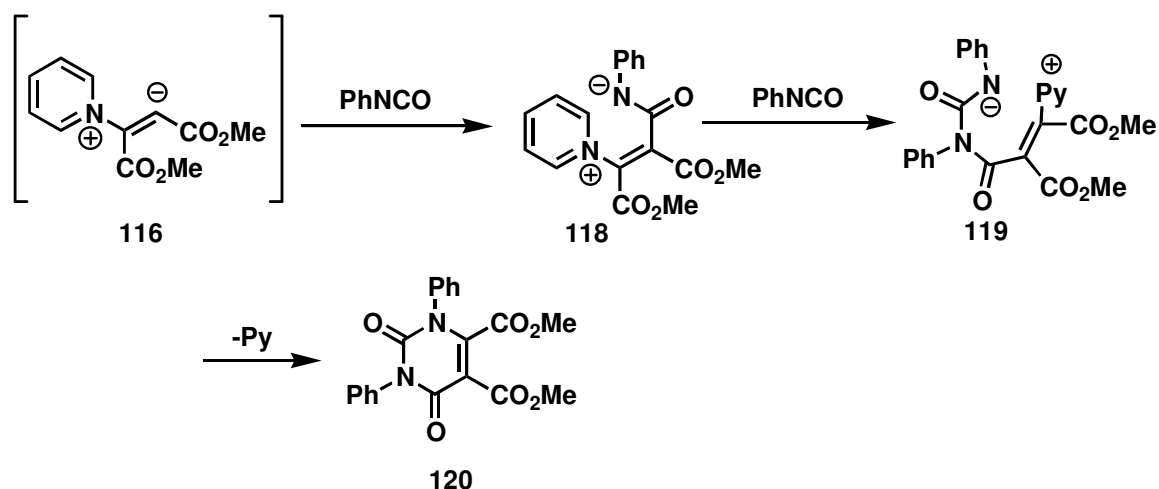

Scheme 1.34

Huisgen has successfully applied the idea of 1,4-dipole to another N-heterocycle like isoquinoline. He showed that the zwitterion formed by the addition of isoquinoline **121** to DMAD on reaction with dipolarophiles such as phenyl isocyanate afforded condensed isoquinoline derivative **123** (Scheme 1.35).⁴⁵

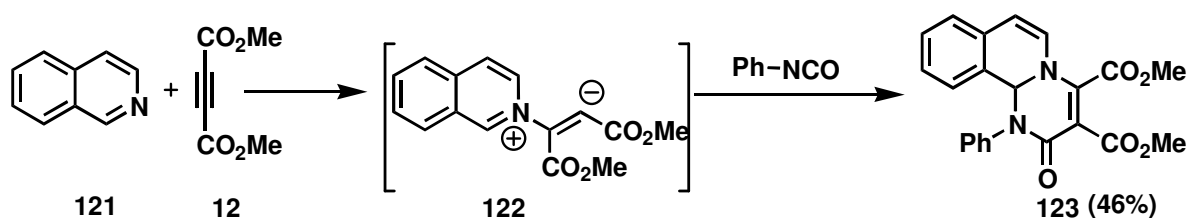

Scheme 1.35

Later, in 1975 Abbott *et al.* studied the reactivity of benzothiazole **124** towards DMAD. This reaction afforded the 1:2 adducts **126** and **127**. Their investigations indicated that the reaction proceeded *via* the intermediacy of the 1,4-dipole **125** generated from benzothiazole and DMAD (Scheme 1.36).⁴⁶

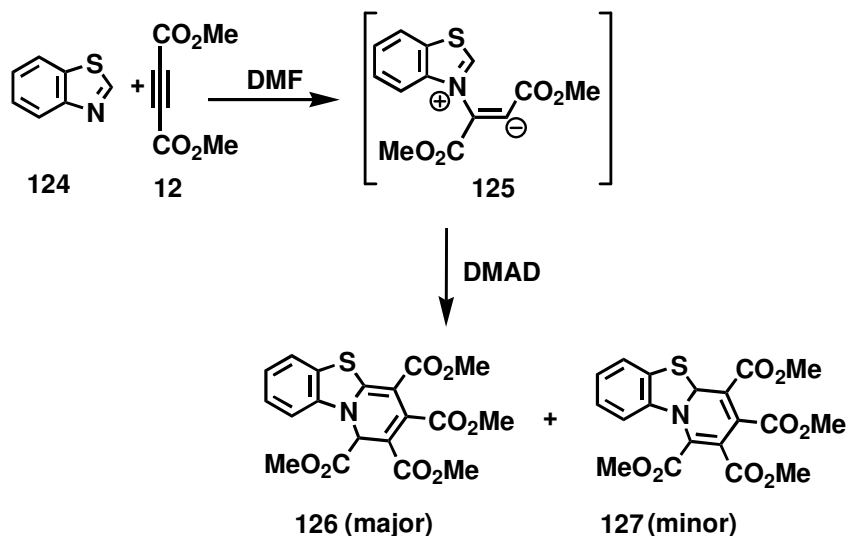

Scheme 1.36

1.7 Present Work

It is evident from the literature survey presented above that 1,4-dipolar intermediates are useful and interesting species which can provide a unique and facile method for the construction of various six membered heterocycles. However their synthetic potential remained underexploited. In this context we undertook a detailed investigation of the formation of the zwitterions by the reaction of nitrogen containing heterocyclic compounds with activated acetylene and the interception of these zwitterions with various electrophiles in one pot. The activated alkyne of choice was dimethyl acetylenedicarboxylate (DMAD). The nucleophiles employed in the study are isoquinoline, benzothiazole and pyridine.

In the first phase of the work, we have explored the reactivity pattern of the 1:1 intermediate formed by the addition of isoquinoline and DMAD with electrophilic styrenes and isatilidenes. The results comprise the subject matter of second chapter.

The second phase of our study was focused on the synthesis of pyrido benzothiazole derivatives *via* the reaction of the zwitterion generated from benzothiazole and DMAD with electrophilic styrenes.

The last phase of the investigation involved the synthesis of substituted 1,3-butadiene derivatives by the reaction of DMAD with arylidene malononitriles, catalyzed by pyridine

Details of these studies are presented in the following chapters of the thesis.

1.8 References

1. 'Hetero Diels-Alder Methodology in Organic Synthesis'; Boger, D. L.; Weinreb, S. M. Eds.; Academic press: san Diego, 1987.
2. a) Huisgen, R. in 'Topics in Heterocyclic Chemistry'; Castle, R., Ed; John Wiley and sons: New York, 1969, Chapter 8, 223. b) Huisgen, R.; *Ger. Z. Chem.* **1968**, 8 (8), 290.
3. Regnault, V. *Ann. De. Chem.* [2] **1837**, 65, 98.
4. a) Bordwell, F. G.; Colton, F. B.; Knell, M. *J. Am. Chem. Soc.* **1954**, 76, 3950. b) Eitner, P. *Ber. Dtsch. Chem. Ges.* **1892**, 25, 461.
5. 'The Adventure Playground of Mechanisms and Novel Reactions'; Huisgen, R. American Chemical Society, Washington, DC, 1994, p 153.
6. Huisgen, R.; Morikawa, M.; Herbig, K.; Brunn, E. *Chem. Ber.* **1967**, 100, 1094.
7. Huisgen, R. *Liebigs Ann. Chem.* **1965**, 688, 98.
8. a) Butler, G. B.; Turner, S. R.; Wagener, K. B. *J. Org. Chem.* **1972**, 37, 1454. b) Butler, G. B.; Wagner, K. B. *J. Org. Chem.* **1973**, 38, 3070.
9. Butler, G. B.; Turner, S. R.; Guilbault, I. J. *J. Org. Chem.* **1971**, 36, 28, 38.
10. Sepulveda-Arques, J.; Simon, M. M. *Tetrahedron Lett.* **1985**, 26, 6357.
11. Ghosez, L.; de Perez, C. *Angew. Chem., Int. Ed. Engl.* **1971**, 10, 184.
12. a) Hassner, A.; Miller, A. S.; Haddadin, M. J. *Tetrahedron Lett.* **1972**, 1353. b) Woerner, F. P.; Reimlinger, H.; Mereny, R. *Chem. Ber.* **1971**, 104, 2786. c) Ghosez, L.; Rens, M. *Chem. Ber.* **1970**, 103, 3765.
13. Schaumann, E.; Kausch, E.; Walter, W. *Chem. Ber.* **1974**, 107, 3574.

14. Huisgen, R.; Steiner, G. *J. Am. Chem. Soc.* **1973**, *95*, 5054.
15. Huisgen, R.; Steiner, G.; Schug, R. *Angew. Chem., Int. Ed. Engl.* **1974**, *13*, 80.
16. Machiguchi, T.; Okamoto, J.; Takachi, J.; Hasegawa, T.; Yamabe, S.; Minato, T. *J. Am. Chem. Soc.* **2003**, *125*, 14446.
17. a) Potts, K. T.; Sorm, M. *J. Org. Chem.* **1972**, *37*, 1422. b) Potts, K. T.; Ehlinger, R.; Nichols, W. M. *J. Org. Chem.* **1975**, *40*, 2596.
18. Potts, K. T.; Sorm, M. *J. Org. Chem.* **1971**, *36*, 8.
19. a) Gotthardt, H.; Riegels, M. *Chem. Ber.* **1988**, *121*, 1143. b) Gotthardt, H.; Riegels, M. *Chem. Ber.* **1987**, *120*, 445. c) Gotthardt, H.; Riegels, M. *Chem. Ber.* **1986**, *119*, 1315.
20. Gotthardt, H.; Schenk, K. H. *Chem. Ber.* **1985**, *118*, 4567.
21. Padwa, A.; Coats, S. J.; Semones, M. A. *Tetrahedron Lett.* **1993**, *34*, 5405.
22. Potts, K. T.; Dery, M. O.; Kullnig, R. K. *J. Chem. Soc., Chem. Commun.* **1987**, 840.
23. Padwa, A.; Haring, S. R.; Semones, M. A. *J. Org. Chem.* **1995**, *60*, 2952.
24. Padwa, A.; Semones, M. A. *Tetrahedron Lett.* **1996**, *37*, 335.
25. a) Eisenhuth, W.; Renfro, H. B.; Schmid, H. *Helv. Chim. Acta.* **1965**, *48*, 375. b) Kozikowski, A. P.; Schmiesing, R. *Synth. Commun.* **1978**, *8*, 363.
26. Hauser, F. M.; Prasanna, S.; Combs, D. W. *J. Org. Chem.* **1983**, *48*, 1328.
27. Broom, N. J.; Sammes, P. G. *J. Chem. Soc., Chem. Commun.* **1978**, 162.
28. a) Kraus, G. A.; Sugimoto, H. *Tetrahedron Lett.* **1978**, *19*, 2263. b) Lit, T.; Wu, Y. *J. Am. Chem. Soc.* **1981**, *103*, 7007. c) Morrow, G. W.; Swenton, J. S.; Filipi, J. A.; Wolgemuth, R. L. *J. Org. Chem.* **1987**, *52*, 713.
29. Dodd, J. H.; Weinreb, S. M. *Tetrahedron Lett.* **1979**, *20*, 3593.
30. Mann, A.; Ungureanu, I.; Klotz, P.; Schoenfelder, A. *Chem. Commun.* **2001**, 958.

-
31. Singh, V. K.; Prasad, B. A.; Bisai, A. *Org. Lett.* **2004**, *6*, 4829.
 32. Swenton, J. S.; Jackson, D. K.; Narasimhan, L. *J. Am. Chem. Soc.* **1979**, *101*, 3989.
 33. Biehl, E. R.; Khanapure, S. P.; Bhawal, B. M. *Tetrahedron Lett.* **1990**, *31*, 2869.
 34. Bach, R. D.; Wendt, J. A.; Gauvreau, P. J. *J. Am. Chem. Soc.* **1994**, *116*, 9921.
 35. Rigby, J. H. *Synlett* **2000**, 1.
 36. Rigby, J. H.; Balasubramanian, N. *J. Org. Chem.* **1984**, *49*, 4569.
 37. Rigby, J. H.; Holsworth, D. D. *Tetrahedron Lett.* **1991**, *32*, 5757.
 38. Rigby, J. H.; Qabar, M. N. *J. Am. Chem. Soc.* **1991**, *113*, 8975.
 39. Rigby, J. H.; Cawzza, A.; Ahmed, G. *J. Am. Chem. Soc.* **1996**, *118*, 12848.
 40. Heydt, H.; Regitz, M. in *1,3-Dipolar Cycloaddition Chemistry*; Padwa, A. Ed. Vol I, Wiley, New York 1984; pp 393.
 41. Facklam, T.; Wagner, O.; Heydt, H.; Regitz, M. *Angew. Chem., Int. Ed. Engl.* **1990**, *29*, 314.
 42. Bertrand, G.; Tejada, J.; Riau, R.; Dahan, F. *J. Am. Chem. Soc.* **1993**, *115*, 7880.
 43. Niecke, E.; Nieger, M.; Dombrowski, A. *Chem. Commun.* **1996**, 1705.
 44. Diels, O.; Alder, K. *Liebigs Ann. Chem.* **1932**, *498*, 16.
 45. Acheson, R. M. *Adv. Hetrocycl. Chem.* **1963**, 125.
 46. Huisgen, R.; Morikawa, M.; Herbig, K.; Brunn, E. *Chem. Ber.* **1967**, *100*, 1094.
 47. Abbott, P. J.; Acheson, R. M.; Eisner, U.; Watkin, D. J.; Carruthers, J. R. *J. Chem. Soc., Chem. Commun.* **1975**, 155.

Novel One Pot Synthesis of Tetrahydrobenzoquinolizine Derivatives and Oxindolinydene Derivatives *via* Huisgen 1,4-Dipolar Cycloaddition Reactions

2.1 Introduction

The phenomenal success of the Huisgen 1,3-dipolar cycloaddition reaction leading to the synthesis of five-membered heterocycles¹ paved the way for devising its homologous version, *viz.*, 1,4-dipolar cycloaddition reaction.² The 1,4-dipolar cycloaddition reactions of interest to us are, incidentally, multicomponent reactions (MCRs). The investigations documented in this chapter are primarily concerned with the MCRs involving isoquinoline, dimethyl acetylenedicarboxylate (DMAD) and dipolarophiles such as arylidenemalononitriles and isatylidene derivatives. In this context, a general description of MCRs and some important 1,4-dipolar cycloaddition reactions of isoquinoline is considered essential and therefore the following section is given as a background.

2.1.1 Multicomponent Reactions (MCRs)

Reactions in which more than two starting materials react to form product/products in such a way that all or most of the atoms of the starting materials are retained in the product are called multicomponent reactions.³ The reagents employed may be different compounds or they may be different functional groups of

the same reagent. These reactions can either be carried out in solution or on a solid support.

In recent years, MCRs have found application in the efficient one pot synthesis of polycyclic systems *via* zwitterionic intermediates. Advantages of using this type of reactions are their convergence, atom economy, productivity, facile execution and generally high yields of products. In the following section a brief introduction to MCR based 1,4-dipolar cycloadditions is provided.

2.1.1a The Huisgen 1,4-Dipolar Cycloaddition Reactions of Isoquinoline

The concept of 1,4-dipolar cycloaddition reaction was introduced by Huisgen in 1967, which provided a unique and facile method for the synthesis of six-membered heterocyclic compounds (see chapter 1 for a detailed review of 1,4-dipolar cycloadditions). In his pioneering work, Huisgen showed that the reaction of isoquinoline, DMAD and the dipolarophiles, phenyl isocyanate, diethyl mesoxalate and dimethyl azodicarboxylate led to the formation of condensed isoquinoline derivatives.⁴

Later, Acheson and co-workers have done extensive studies on this 1,4-dipole generated from isoquinoline and DMAD and they found that the nature of the product depends on the solvent used. Thus, in the absence of other trapping agents, the 1,4-dipole in methanol gave the benzoindolizine **4** derivative. When ether was used as the solvent the adduct tetramethyl[11*b*]*H*-benzo[*a*]quinolizine-1,2,3,4-tetracarboxylate **5** was obtained. However, in boiling xylene the corresponding stable adduct, tetramethyl-4*H*-benzo[*a*]quinolizine-1,2,3,4-tetracarboxylate **3** was formed (Scheme 2.1).⁵

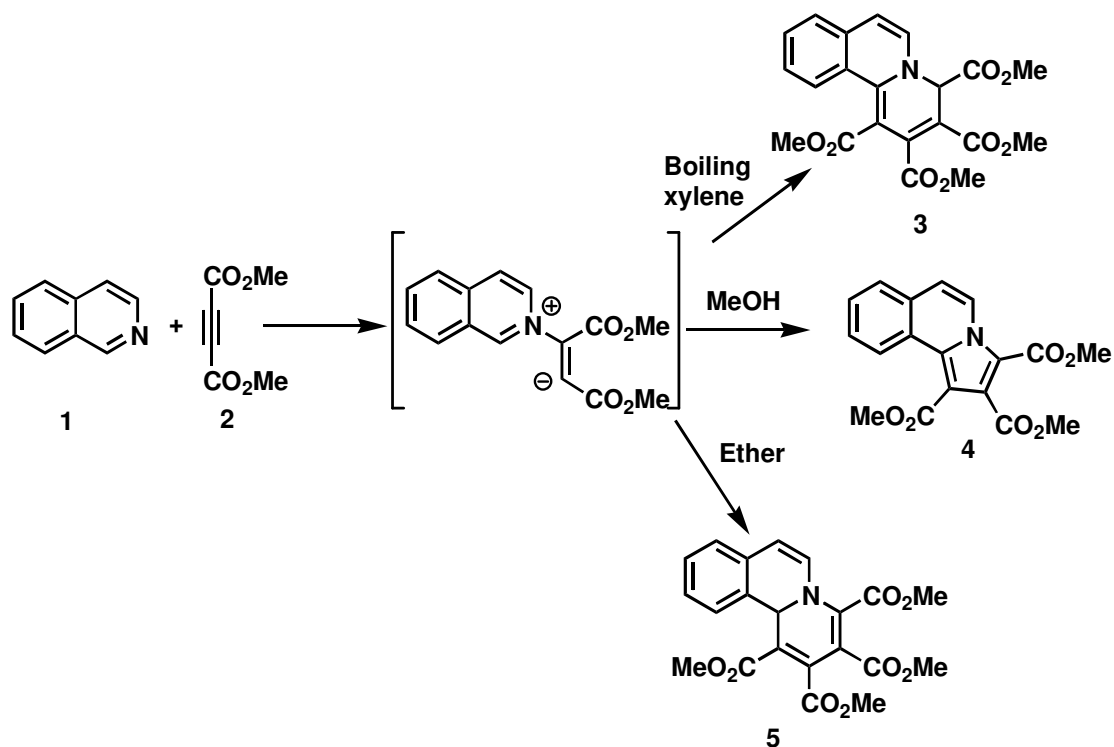

Scheme 2.1

Huisgen and Herbig have observed that 3,4-dihydroisoquinoline **6**, on reaction with excess DMAD afforded the normal addition product benzoquinolizine derivative **8**. With the imine component in excess, the pyrimido[2,1,*a*:4,3*a'*]isoquinoline derivative **7** was formed. Both these products presumably arise through the 1,4-dipolar intermediate (Scheme 2.2).⁶

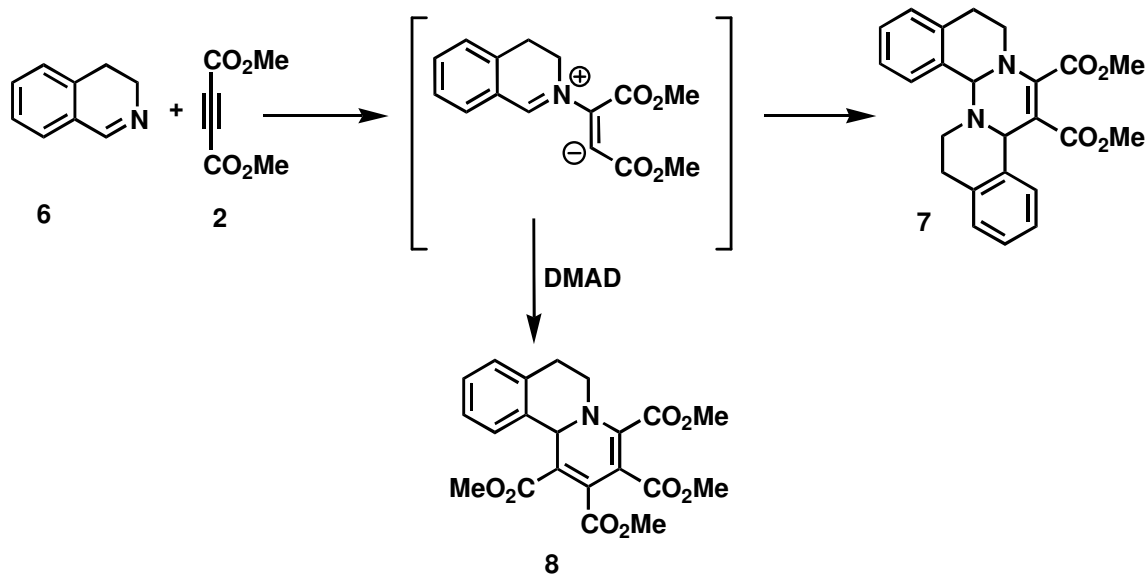

Scheme 2.2

While exploring the synthetic potential of the 1:1 zwitterionic intermediate formed by the addition of isoquinoline to DMAD, it was found that this 1,4-dipole could be successfully intercepted by dipolarophiles like *N*-tosylimines **9** giving the corresponding 2*H*-pyrimido[2,1-*a*]isoquinoline derivatives **10a** and **10b** in excellent yields, thereby constituting a novel multicomponent reaction (Scheme 2.3).⁷

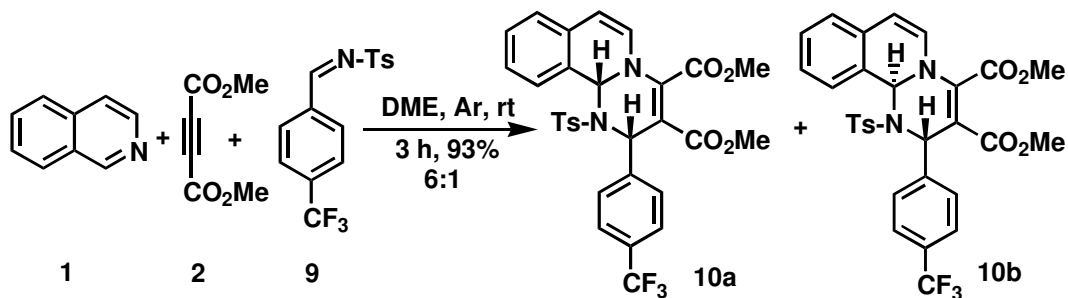

Scheme 2.3

Subsequently it was found that *o*-quinones **11** also serve as good dipolarophiles towards isoquinoline-DMAD zwitterion, leading to the formation of spiro [1,3]-oxazino[2,3-*a*]isoquinoline derivatives **12a** and **12b** in good yields (Scheme 2.4).⁸

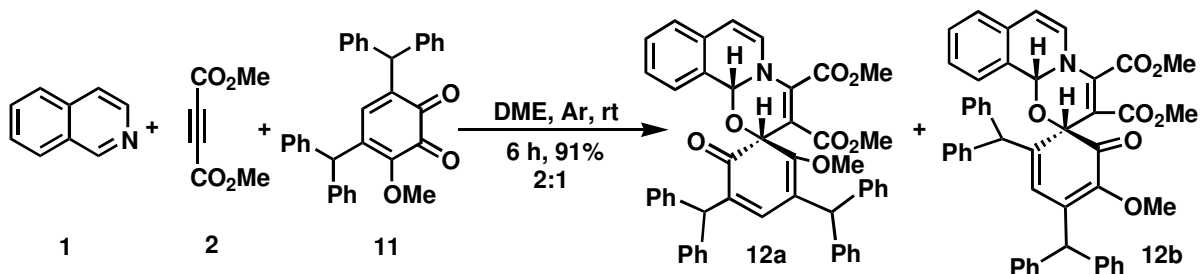

Scheme 2.4

Recently, a three-component reaction involving isoquinoline, *gem*-diactivated olefins **13** and isocyanides leading to the formation of dihydropyrroloisoquinoline systems **14** was reported by Mironov.⁹ The reaction occurs *via* the [4+1] annulation of the isocyanide and the 1,4-dipole, formed from isoquinoline and olefin (Scheme 2.5).

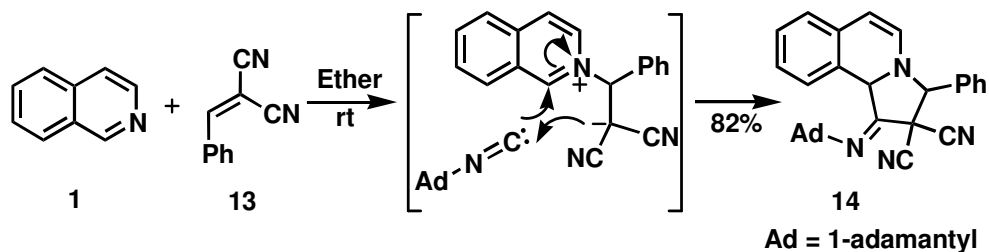

Scheme 2.5

2.2 Background to the Present Work

Recent work in our laboratory has shown that the reaction of *tert*-butyl isocyanide **15**, DMAD and 3-nitrobenzylidenemalononitrile **16** afforded a fully substituted cyclopentadiene derivative **17** in good yield (Scheme 2.6).¹⁰

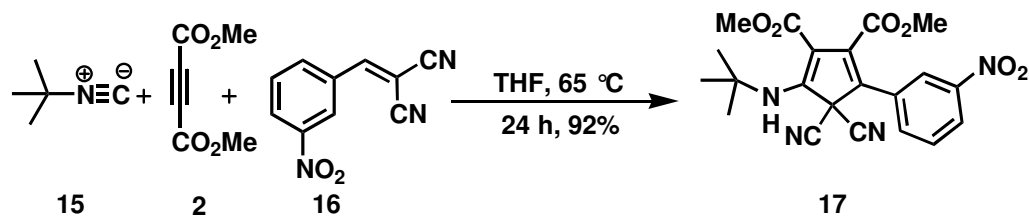

Scheme 2.6

Related studies have shown that the dipolar species formed by the addition of dimethoxycarbene, generated from its precursor **18**, with DMAD can also be trapped with arylidene malononitrile **13** leading to the formation of highly substituted cyclopentene derivative **19** in good yields (Scheme 2.7).¹¹

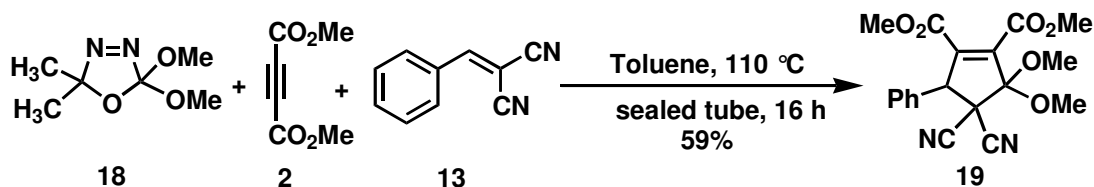

Scheme 2.7

Impressed by the reactivity of arylidene malononitriles in various MCRs, it was decided to explore the reaction of zwitterionic intermediates generated from isoquinoline and DMAD with arylidene malononitriles and isatylidene derivatives. The results of our investigations leading to the formation of tetrahydrobenzoquinolizine derivatives and oxindolinylidene derivatives respectively are discussed in the following sections.

2.3 Results and Discussion

The dicyanostyrenes were prepared by the condensation of aromatic aldehydes with malononitriles in presence of ammonium acetate and a trace amount of acetic acid at 60 °C in benzene for 6 h (Scheme 2.8).

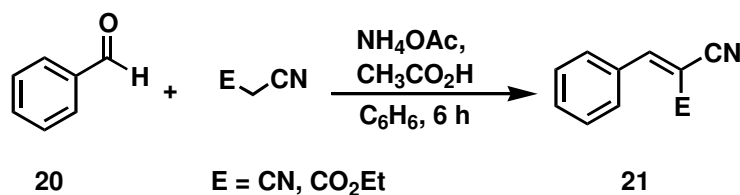

Scheme 2.8

2.3.1 Reaction of Isoquinoline and DMAD with Benzylidenemalononitriles

In a pilot experiment, a solution of dimethyl acetylenedicarboxylate (DMAD) and benzylidenemalononitrile in 10 mL of dry THF was stirred under an argon atmosphere. To this, isoquinoline was added and the reaction mixture was stirred for 23 h at room temperature. The solvent was then distilled off under vacuum and the residue, on chromatographic separation on silica gel using hexane-ethyl acetate mixture (85:15) as the eluent gave the cycloadduct dimethyl 1,1-dicyano-2-(4-chlorophenyl)-1,11b-dihydro-2*H*-pyrido[2,1-*a*]isoquinoline-3,4-dicarboxylate **23a** (*cis*, 56%) and **23b** (*trans*, 25%) as a pale yellow crystalline solids (Scheme 2.9).

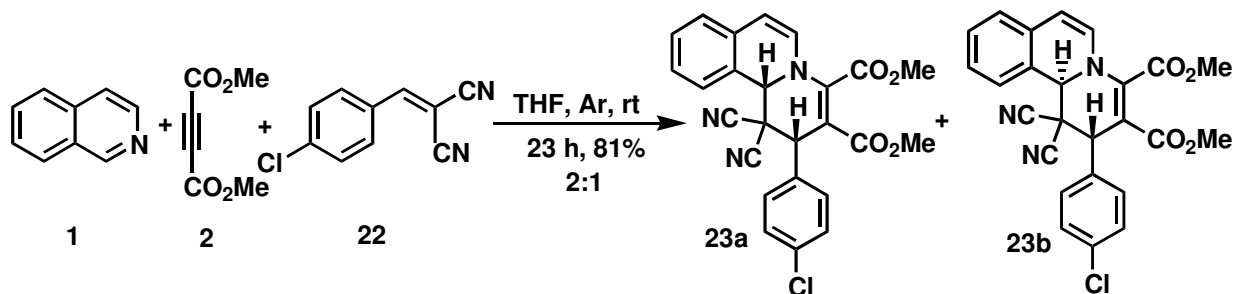

Scheme 2.9

The major diastereomer was isolated by repeated column chromatography and characterized on the basis of spectroscopic analysis. A strong absorption at 1742 cm^{-1} in the IR spectrum of **23a** indicated the presence of ester carbonyl groups, whereas the absorption at 2239 cm^{-1} corresponded to the cyano groups. In the ^1H NMR spectrum (Figure 2.1), the ring junction proton resonated at δ 5.33 as a singlet and the other benzylic proton displayed a singlet at δ 4.58. The two methoxy carbonyl groups were visible at δ 4.00 and 3.49 as singlets. The hydrogens of the enamine double bond appeared as doublets at δ 6.36 ($J = 7.84\text{ Hz}$) and 5.79 ($J = 7.84\text{ Hz}$). In the ^{13}C NMR spectrum, the characteristic signal due to the carbomethoxy carbonyls were seen at δ 164.5 and 164.2; the corresponding methyl carbons were discernible at δ 53.7 and 52.1, while the signal due to the two cyano carbons were observed at δ 111.6 and 112.0. All other signals were in accordance with the structure assigned. The compound also afforded satisfactory HRMS data. Finally, the structure and stereochemistry of the major diastereomer, **23a**, was unequivocally confirmed by single crystal X-ray analysis (Figure 2.3).

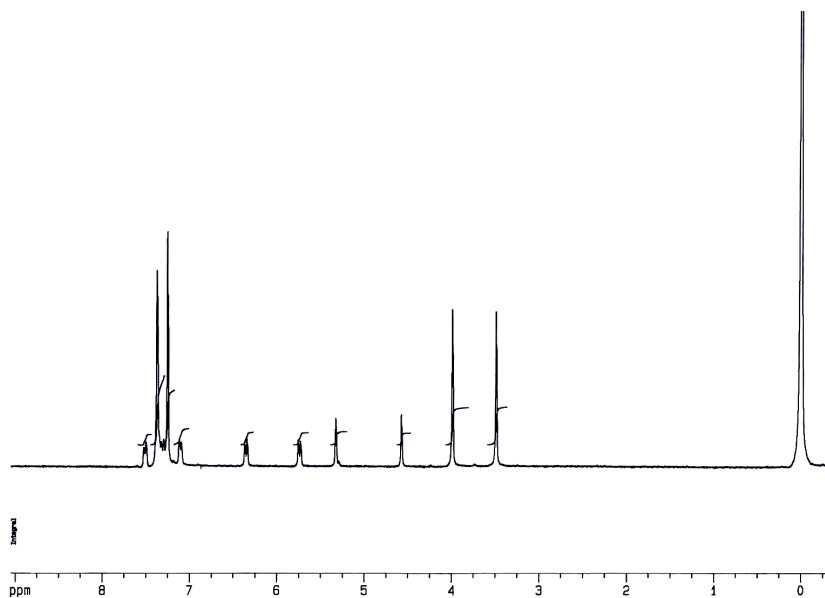

Figure 2.1: ^1H NMR spectrum of **23a**.

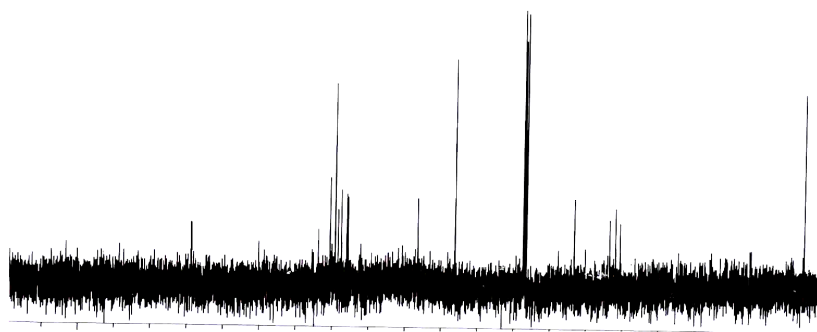

Figure 2.2: ^{13}C NMR spectrum of **23a**.

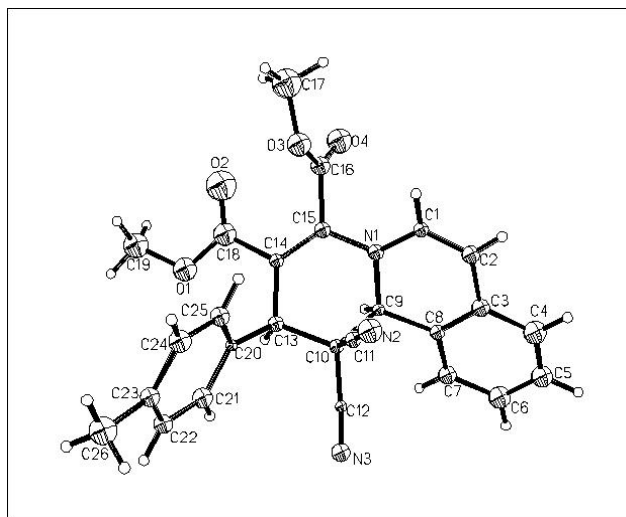
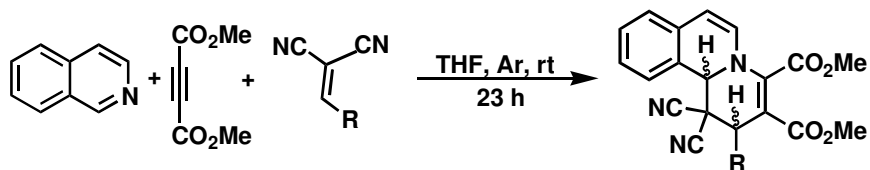

Figure 2.3: Single crystal X-ray structure of **23a**.

The reaction was found to be general with respect to various arylidenemalononitriles affording diastereomeric mixtures of the corresponding tricyclic *cis* derivatives in moderate yields and the *trans* derivatives in comparatively low yields (Table 2.1). The isomers were isolated by repeated column chromatography. The diastereomeric ratios of the products were determined by the ^1H NMR spectroscopic analysis of the mixtures.

Table 2.1. Reaction of isoquinoline and DMAD with various dicyanostyrenes.

Entry	Styrene	Products (cis:trans)	Isolated Yield (%) (cis:trans)
1	 24	 25a : 25b	49:13
2	 26	 27a : 27b	52:19
3	 28	 29a : 29b	51:15
4	 30	 31a : 31b	64:25

Table 2.1 continuation

Entry	Styrene	Products (cis:trans)	Isolated Yield (%) (cis:trans)
5	 32	 33a : 33b	55:10
6	 34	 35a : 35b	42 ^b (1:1)
7	 36	 37a	53 ^a
8	 38	 39a	58 ^a
9	 40	 41a	48 ^a

Table 2.1 continuation

Entry	Styrene	Products (cis:trans)	Isolated Yield (%) (cis:trans)
10	 42	 43a	43 ^a
11	 44	 45a	29 ^a

^a: only one diastereoisomer was formed. ^b: diastereomeric ratio of the separable mixture is given in parentheses.

In some cases, only one isomer was formed and the stereochemistry of an illustrative example, **37a**, was assigned as *cis* by ¹H nOe difference spectroscopic studies (Figure 2.4). Selective irradiation of H_a produced enhancements in the signals corresponding to H_b and H_c (Figure 2.5).

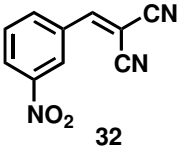
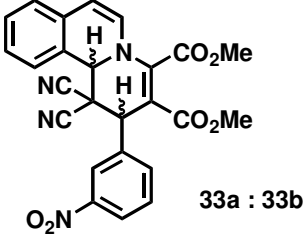
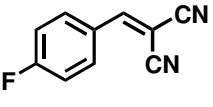
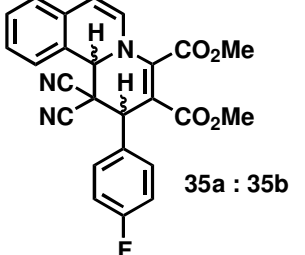
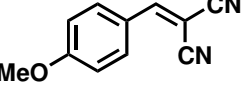
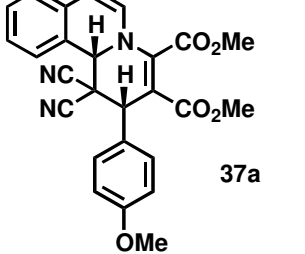
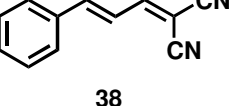
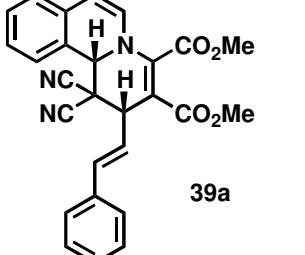
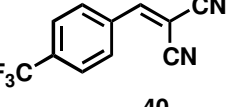
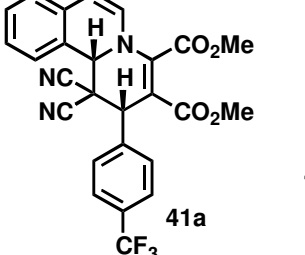
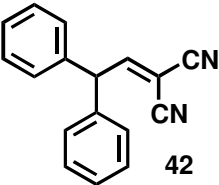
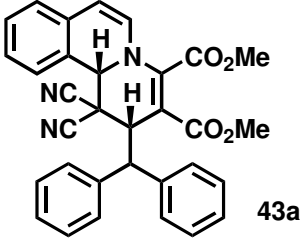
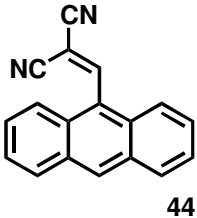
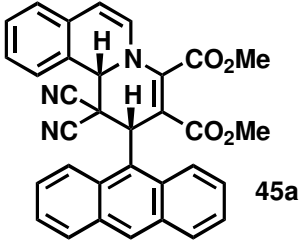
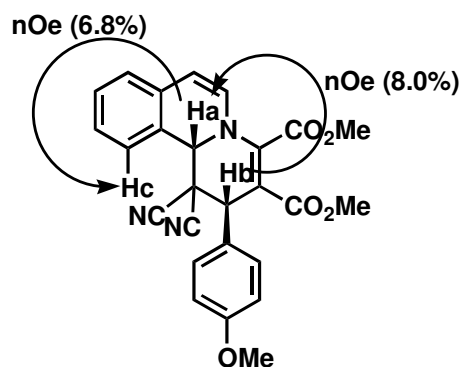

Figure 2.4: Selected nOe correlations for **37a**

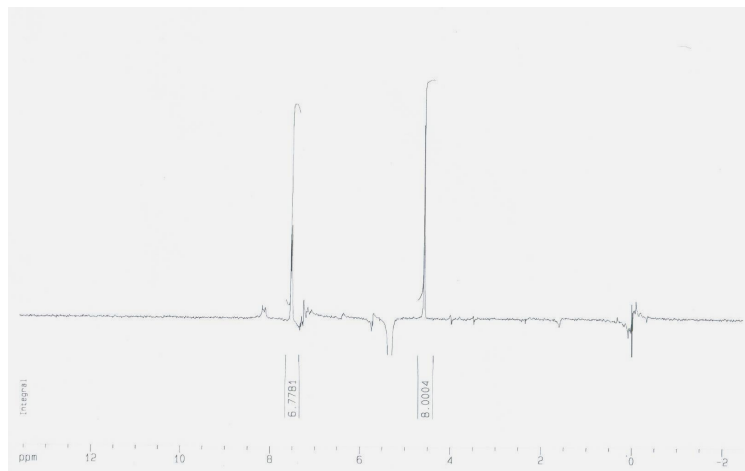
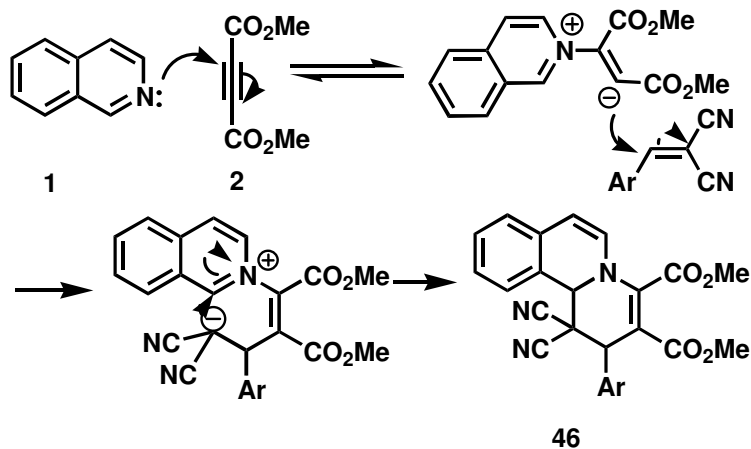

Figure 2.5: Enhancement of signal H_b due to H_a and H_c of **37a**

2.3.1a Mechanistic Considerations

Mechanistically, the reaction may be considered to proceed *via* the initial formation of the 1,4-dipolar intermediate from isoquinoline and DMAD followed by its trapping with arylidenemalononitriles, presumably by a two step process, to give the final product **46** (Scheme 2.10).



Scheme 2.10

2.3.2 Reaction of Isoquinoline and DMAD with Arylcynoacrylates

The alkene component of the MCR is variable. In an illustrative reaction, when aryl cyanoacrylate **47** was used instead of arylidenemalononitrile, 1-cyano-2-(4-fluorophenyl)-1,11b-dihydro-2*H*-pyrido[2,1-*a*]isoquinoline-1,3,4-tricarboxylic acid-1-ethyl ester-3,4-dimethyl ester **48** was obtained as a single diastereomer *albeit* in moderate yield (Scheme 2.11).

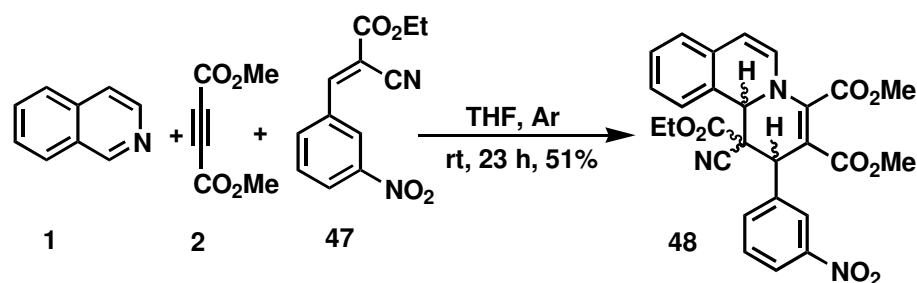

Scheme 2.11

The structure of the product was assigned on the basis of spectroscopic analysis. The strong absorptions at 1740 and 1738 cm^{-1} in the IR spectrum indicated the presence of ester carbonyl groups, whereas the absorption at 2236 cm^{-1} corresponded to the cyano group. In the ^1H NMR spectrum, the ring junction proton resonated at δ 5.36 as a singlet and the other benzylic proton displayed a singlet at δ 4.51. The signals of methylene protons of the ester group displayed an uneven quartet centered at δ 4.42. The two alkoxy carbonyl groups were visible at δ 3.91 and 3.33 as singlets. The hydrogens of the enamine double bond appeared as doublets at δ 6.22 ($J = 7.21$ Hz) and 5.71 ($J = 7.21$ Hz). The methyl protons of the ester functionality were discernible as a triplet at δ 1.15. In the ^{13}C NMR spectrum, the characteristic signal due to the carboalkoxy carbonyls were seen at δ 168.3, 164.2 and 162.4, the corresponding methyl carbons were discernible at δ 53.6 and 51.7, while the signal of

the cyano carbon was observed at δ 112.1. All other signals were in accordance with the structure assigned. The compound also afforded satisfactory HRMS data.

The reaction was found to be general with respect to various aryl cyanoacrylates. The results are summarized in Table 2.2. Surprisingly, no reaction occurred when benzylidenemalonate was used as the third component.

Table 2.2. Reaction of isoquinoline and DMAD with aryl cyanoacrylates.

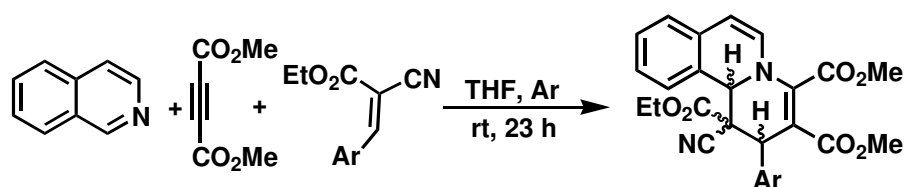

Entry	Styrene	Product	Yield (%)
1	 49	 50	46
2	 51	 52	33
3	 53	 54	45

In all cases, the compounds were completely characterized and their structures were established by spectroscopic methods.

2.3.3a Preparation of Isatilidene Derivatives

The isatin derivatives **56** were prepared by the base catalyzed reaction of isatin **55** with alkyl halides and the isatilidenes **57** were prepared by the condensation of the corresponding isatin derivatives with malononitrile in presence of ammonium acetate and a trace amount of acetic acid at 60 °C in benzene for 6 h (Scheme 2.12).

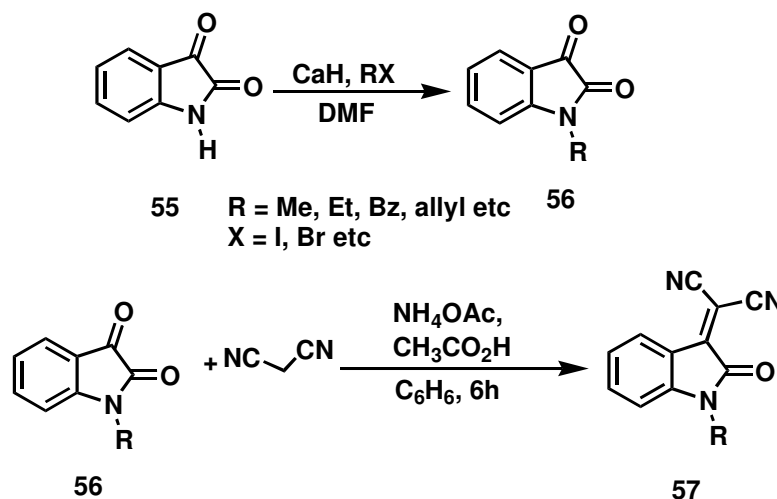

Scheme 2.12

2.3.3b Reaction of Isoquinoline and DMAD with Isatilidene Derivatives

Prompted by the success in developing a synthesis of tetrahydrobenzoquinolizine derivatives by the reaction of arylidenemalononitriles with 1,4-dipoles generated from isoquinoline and DMAD, it was reasoned that a similar reaction would occur with isatilidenes to afford oxindolinylidene derivatives. The results of our investigations, validating the assumption are presented here.

Our investigations were initiated by treating a solution of DMAD and isatilidene derivative **58** in anhydrous THF with an equimolar quantity of isoquinoline

at room temperature. Chromatographic separation of the reaction mixture afforded the spirocyclic derivative **59** as a yellow crystalline solid in 48% yield (Scheme 2.13).

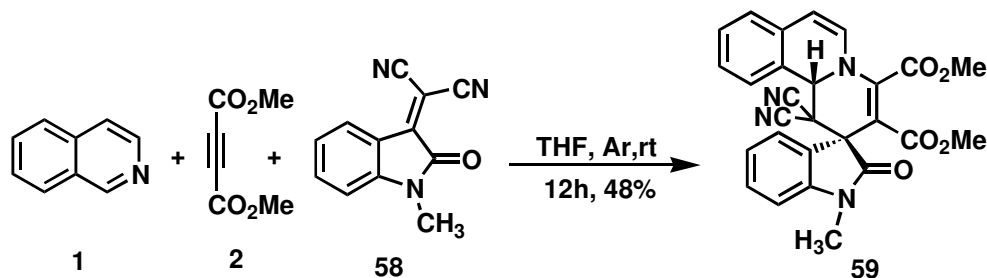

Scheme 2.13

The structure of the product was established by spectroscopic techniques. In the IR spectrum, absorption at 2252 cm^{-1} can be attributed to the cyano group and the sharp bands at 1745 and 1714 cm^{-1} were assigned to the ester carbonyl groups. The absorption band at 1679 cm^{-1} was attributed to the amide carbonyl. The ^1H NMR spectrum displayed the two methoxy groups as singlets at δ 3.98 and 3.41 and the ring junction proton resonated at δ 6.37 as a singlet. The hydrogens of the enamine double bond appeared as doublets at δ 6.41 (d, $J = 7.27\text{ Hz}$, 1H) and δ 5.55 (d, $J = 7.27\text{ Hz}$, 1H). In the ^{13}C NMR spectrum, the two cyano groups resonated at δ 111.5 and 111.9. The amide carbonyl was discernible at δ 174.9 and the two ester carbonyls were seen at δ 164.2 and 163.6. All other signals were also in good agreement with the assigned structure. The compound gave satisfactory HRMS data also.

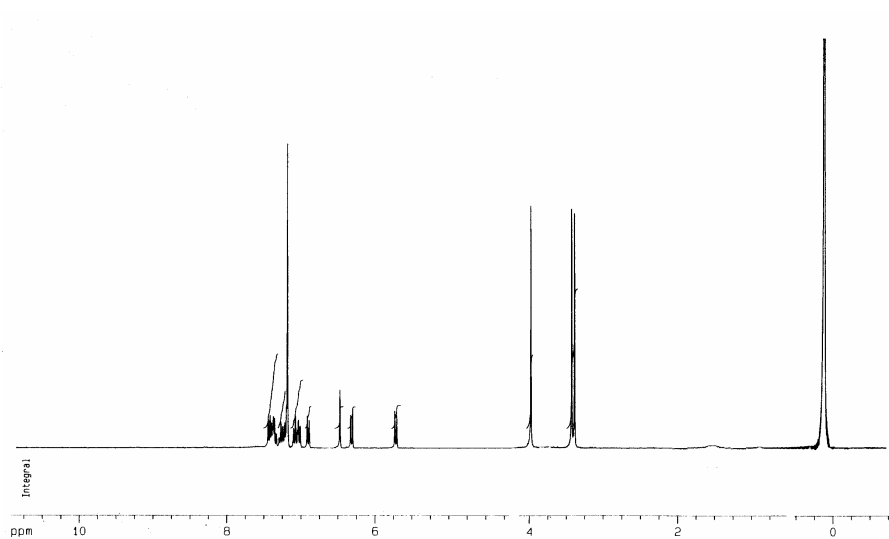

Figure 2.6: ^1H NMR spectrum of **59**

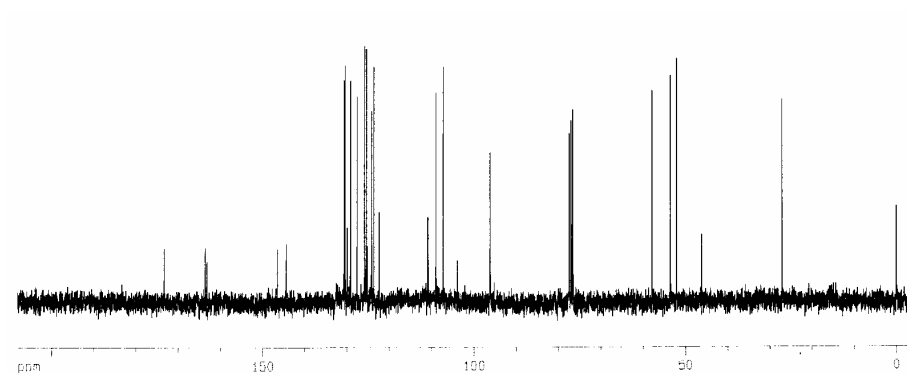

Figure 2.7: ^{13}C NMR spectrum of **59**

The final confirmation of the structure and stereochemistry of **59** was obtained by single crystal X-ray analysis (Figure 2.8).

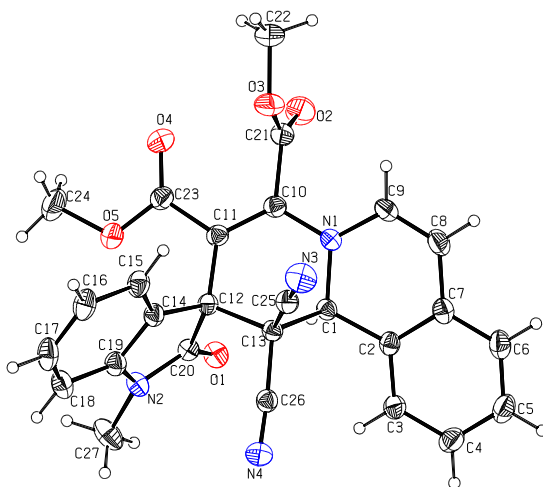
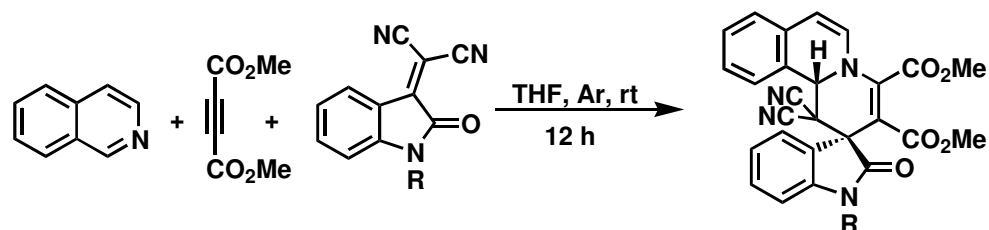

Figure 2. 8: Single crystal X-ray structure of **59**

The results obtained with similar substrates are presented in Table 2.3.

Table 2.3. Reaction of isoquinoline and DMAD with various isatlidene derivatives.

Entry	Isatlidene Derivatives	Product	Yield(%)
1	 60	 61	39
2	 62	 63	61
3	 64	 65	54
4	 66	 67	45

Table 2.3. continuation

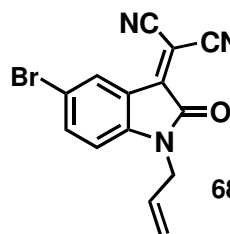
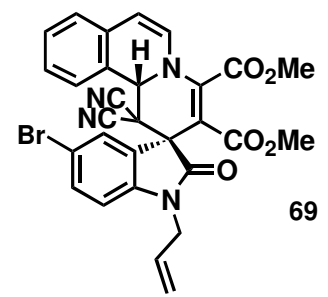
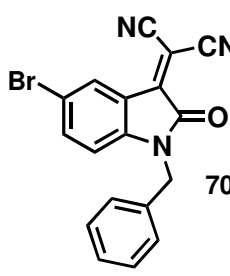
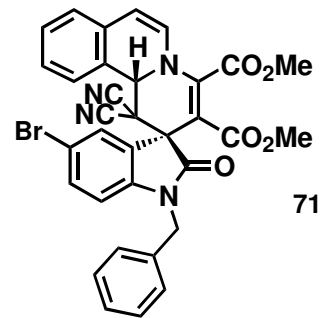
Entry	Isatilidene Derivatives	Product	Yield(%)
5	 68	 69	42
6	 70	 71	51

In all the cases, the products were completely characterized and their structures established by spectroscopic methods.

2.3.3c Mechanistic Considerations

Mechanistically, in this reaction the initial step involves the formation of a 1:1 zwitterionic intermediate between isoquinoline and DMAD. This 1,4-dipole adds to the electrophilic carbon-carbon double bond of isatilidene presumably by a two step process yielding the formal [4+2] cycloadduct **61** (Scheme 2.14).

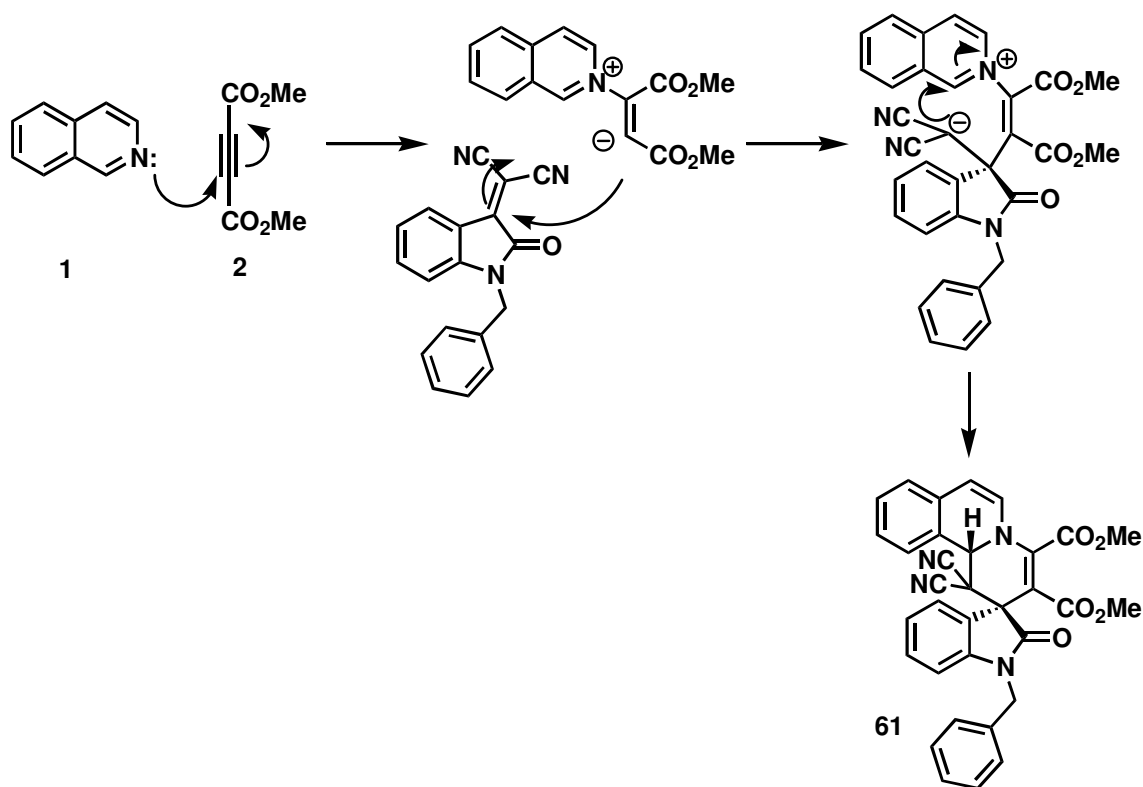

Scheme 2.14

2.4 Conclusion

In conclusion, we have demonstrated the novel reactivity of activated styrenes towards the 1:1 zwitterionic intermediate generated by the addition of isoquinoline to dimethyl acetylenedicarboxylate (DMAD) under mild reaction conditions. These investigations resulted in an efficient one pot synthesis of highly functionalized tetrahydrobenzoquinolizine derivatives. Similarly, when isatylidenes were used as dipolarophiles, various oxindolinylidene derivatives were obtained.

2.5 Experimental Details

General

Melting points were recorded on a Büchi melting point apparatus. NMR spectra were recorded at 300 (^1H) and 75 (^{13}C) MHz respectively on a Bruker Avance DPX-300 MHz FT-NMR spectrometer on samples dissolved in CDCl_3 - CCl_4 mixtures (7/3 v/v). Chemical shifts are reported (δ) relative to TMS (^1H) and CDCl_3 (^{13}C) as the internal standards. Coupling constant (J) is reported in Hertz (Hz). Mass spectra were recorded under EI/HRMS (at 5000) resolution using Auto Spec. M mass spectrometer. IR spectra were recorded on Nicolet Impact 400D FT-IR spectrophotometer. Elemental analyses were performed on a Perkin Elmer-2400 Elemental Analyzer. Dimethyl acetylenedicarboxylate was purchased from Merck and used without further purification. Commercial grade solvents were distilled prior to use. Analytical thin layer chromatography was performed on glass plates coated with silica gel containing calcium sulfate as the binder. Gravity column chromatography was performed using 100-200 mesh silica gel and mixtures of hexane-ethyl acetate were used for elution.

Preparation of Arylidenemalononitrile Derivatives

A solution of aromatic aldehyde (2.87 mmol), malononitrile (8.70 mmol), and ammonium acetate (2.87 mmol) were taken together in 10 mL of benzene. To this a drop of glacial acetic acid was added and was refluxed for 6 h. The solvent was then removed and was worked up in dichloromethane. Recrystallized from Petroleum ether-dichloromethane gave the corresponding arylidenemalononitrile.

Dimethyl-1,1-dicyano-2-(4-chlorophenyl)-1,11b-dihydro-2H-pyrido[2,1-a]isoquinoline-3,4-dicarboxylate (**23a** and **23b**)

A solution of dimethyl acetylenedicarboxylate (DMAD) (132 mg, 0.93 mmol) and the arylidenemalononitrile **22** (188 mg, 0.77 mmol) in dry THF (10 mL) was stirred under an argon atmosphere. To this, isoquinoline **1** (100 mg, 0.77 mmol) was added and the reaction mixture was stirred for 23 h at room temperature. The solvent

was then distilled under vacuum on a rotary evaporator and the residue, on chromatographic separation on silica gel using hexane-ethyl acetate mixture (85:15) gave the product dimethyl-1,1-dicyano-2-(4-chlorophenyl)-1,11b-dihydro-2*H*-pyrido[2,1-*a*]isoquinoline-3,4-dicarboxylate **23a** (56%) and **23b** (25%) as a pale yellow crystalline solids.

M.p.: 121-123 °C.

IR (KBr) ν_{\max} : 2955, 2239, 1742, 1715, 1607, 1526, 1438, 1357, 1236 cm^{-1} .

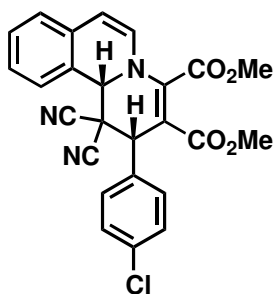

23a

^1H NMR [300 MHz, $\text{CDCl}_3/\text{CCl}_4$, 7:3 (v/v)]: δ 7.52 (d, $J = 7.43$ Hz, 1H), 7.45-7.38 (m, 2H), 7.29 (d, $J = 7.68$ Hz, 2H), 7.30-7.25 (m, 2H), 7.10 (d, $J = 7.84$ Hz, 1H), 6.36 (d, $J = 7.84$ Hz, 1H), 5.79 (d, $J = 7.84$ Hz, 1H), 5.33 (s, 1H), 4.58 (s, 1H), 4.00 (s, 3H), 3.49 (s, 3H).

^{13}C NMR (75 MHz): δ 164.5, 164.2, 133.8, 130.7, 129.3, 128.4, 127.6, 126.1, 125.7, 122.2, 114.2, 113.5, 111.6, 112.0, 110.2, 109.5, 109.3, 108.2, 107.5, 107.2, 106.6, 104.9, 63.3, 53.7, 52.1, 50.7.

HRMS: (EI) Calculated for $\text{C}_{25}\text{H}_{18}\text{N}_3\text{O}_4\text{Cl}$: 459.8809, Found : 459.8879.

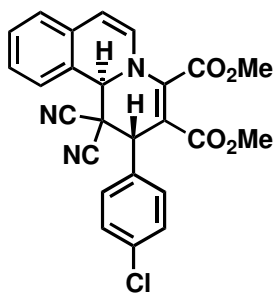

23b

IR (KBr) ν_{\max} : 2933, 2225, 1736, 1710, 1606, 1524, 1442, 1355, 1235 cm^{-1} .

^1H NMR [300 MHz, $\text{CDCl}_3/\text{CCl}_4$, 7:3 (v/v)]: δ 7.48 (d, $J = 7.12$ Hz, 1H), 7.37-7.18 (m, 2H), 7.28 (d, $J = 7.68$ Hz, 2H), 7.16-7.13 (m, 2H), 7.10 (d, $J = 7.84$ Hz, 1H), 6.28 (d, $J = 7.76$ Hz, 1H), 5.79 (d, $J = 7.84$ Hz, 1H), 5.09 (s, 1H), 4.56 (s, 1H), 3.98 (s, 3H), 3.58 (s, 3H).

^{13}C NMR (75 MHz): δ 164.2, 163.3, 132.5, 130.7, 128.1, 128.5, 127.6, 126.1, 125.7, 122.2, 114.2, 113.1, 112.1, 111.2, 109.4, 109.2, 108.5, 107.3, 107.2, 106.4, 104.5, 63.0, 53.5, 52.2, 50.5.

Dimethyl-1,1-dicyano-2-phenyl-1,11b-dihydro-2H-pyrido[2,1-a]isoquinoline-3,4-dicarboxylate (25a and 25b):

A solution of dimethyl acetylenedicarboxylate (DMAD) (132 mg, 0.93 mmol) and **24** (119 mg, 0.77 mmol) in dry THF (10 mL) was stirred under an argon atmosphere. To this, isoquinoline **1** (100 mg, 0.77 mmol) was added and the reaction mixture was stirred for 23 h at room temperature. The solvent was then removed under vacuum and the residue, on chromatographic separation on silica gel using hexane-ethyl acetate mixture (85:15) gave the product dimethyl-1,1-dicyano-2-phenyl-1,11b-dihydro-2H-pyrido[2,1-a]isoquinoline-3,4-dicarboxylate **25a** (49%) and **25b** (13%) as a pale yellow crystalline solids.

Mp.: 139-142 °C.

IR (KBr) ν_{max} : 2963, 2229, 1735, 1710, 1607, 1525, 1443, 1355, 1231 cm^{-1} .

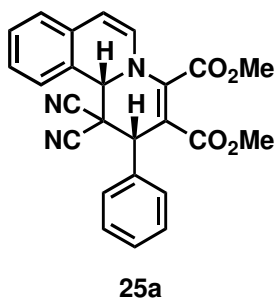

^1H NMR [300 MHz, $\text{CDCl}_3/\text{CCl}_4$, 7:3 (v/v)]: δ 7.59 (m, 2H), 7.55-7.34 (m, 2H), 7.29-7.21 (m, 3H), 7.44-7.32 (m, 2H), 7.11 (d, $J = 8.76$ Hz, 1H), 6.53 (d, $J = 7.90$ Hz, 1H), 6.10 (d, $J = 7.90$ Hz, 1H), 6.07 (s, 1H), 5.31 (s, 1H), 3.89 (s, 3H), 3.46 (s, 3H).

^{13}C NMR (75 MHz): δ 165.6, 163.7, 153.6, 150.6, 144.8, 144.2, 143.9, 141.8, 140.8, 139.1, 133.9, 130.1, 128.8, 128.5, 128.4, 128.0, 127.9, 127.0, 125.2, 112.1, 111.8, 109.0, 107.1, 53.6, 51.7, 29.6.

HRMS: (EI) Calculated for $\text{C}_{25}\text{H}_{19}\text{N}_3\text{O}_4$: 425.4363, Found : 425.4366.

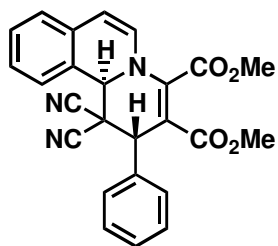

25b

IR (KBr) ν_{\max} : 2965, 2232, 1739, 1713, 1610, 1528, 1441, 1358, 1239 cm^{-1} .

^1H NMR [300 MHz, $\text{CDCl}_3/\text{CCl}_4$, 7:3 (v/v)]: δ 7.57 (m, 2H), 7.51-7.37 (m, 2H), 7.29-7.21 (m, 3H), 7.11 (d, $J = 8.76$ Hz, 1H), 6.53 (d, $J = 7.90$ Hz, 1H), 6.10 (d, $J = 7.90$ Hz, 1H), 6.09 (s, 1H), 5.34 (s, 1H), 3.91 (s, 3H), 3.44 (s, 3H).

^{13}C NMR (75 MHz): δ 165.2, 163.7, 155.3, 151.2, 145.8, 144.2, 143.9, 143.0, 142.1, 141.8, 140.8, 139.1, 133.9, 130.1, 128.8, 128.5, 128.4, 128.0, 127.9, 127.0, 125.2, 112.1, 111.8, 109.0, 107.1, 53.6, 51.7, 29.6.

Dimethyl-1,1-dicyano-2-(4-methylphenyl)-1,11b-dihydro-2H-pyrido[2,1-a]isoquinoline-3,4-dicarboxylate (27a and 27b):

A solution of dimethyl acetylenedicarboxylate (DMAD) (132 mg, 0.93 mmol) and **26** (130 mg, 0.77 mmol) in dry THF (10 mL) was stirred under an argon atmosphere. To this, isoquinoline **1** (100 mg, 0.77 mmol) was added and the reaction mixture was stirred for 23 h at room temperature. The solvent was then removed under vacuum and the residue, on chromatographic separation on silica gel using hexane-ethyl acetate mixture (85:15) gave the product dimethyl-1,1-dicyano-2-(4-methylphenyl)-1,11b-dihydro-2H-pyrido[2,1-a]isoquinoline-3,4-dicarboxylate **27a** (52%) and **27b** (19%) as a pale yellow crystalline solids.

M.p.: 125-128 $^{\circ}\text{C}$.

IR (KBr) ν_{\max} : 3031, 2999, 2221, 1742, 1738, 1610, 1605, 1573, 1520, 1430, 1401, 1358, 1291, 1264, 1103 cm^{-1} .

^1H NMR [300 MHz, $\text{CDCl}_3/\text{CCl}_4$, 7:3 (v/v)]: δ 7.24-7.59 (m, 5H), 7.00-7.15 (m, 3H), 6.27 (d, $J = 7.8$ Hz, 1H), 5.72 (d, $J = 7.8$

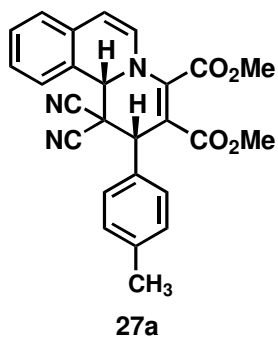

Hz, 1H), 5.15 (s, 1H), 4.55 (s, 1H), 3.97 (s, 3H), 3.57 (s, 3H), 2.39 (s, 3H).

^{13}C NMR (75 MHz): δ 164.1, 163.0, 142.4, 138.8, 132.6, 129.7, 129.5, 129.0, 128.1, 126.4, 125.9, 124.9, 121.8, 112.4, 111.6, 106.5, 105.3, 56.5, 52.9, 46.7, 41.3, 40.0, 39.7, 20.6.

HRMS: (EI) Calculated for $\text{C}_{26}\text{H}_{21}\text{N}_3\text{O}_4$: 439.4628, Found : 439.4579.

IR (KBr) ν_{max} : 3033, 2996, 2219, 1739, 1709, 1614, 1609, 1586, 1525, 1433, 1405, 1361, 1294, 1267, 1106 cm^{-1} .

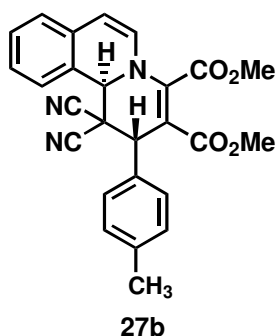

^1H NMR [300 MHz, $\text{CDCl}_3/\text{CCl}_4$, 7:3 (v/v)]: δ 7.51 (d, $J = 7.24$ Hz, 1H), 7.28-7.35 (m, 5H), 7.18 (d, $J = 7.82$ Hz, 1H), 7.09 (d, $J = 7.47$ Hz, 1H), 6.37 (d, $J = 7.75$ Hz, 1H), 5.72 (d, $J = 7.8$ Hz, 1H), 5.32 (s, 1H), 4.56 (s, 1H), 3.99 (s, 3H), 3.48 (s, 3H), 2.36 (s, 3H).

^{13}C NMR (75 MHz): δ 164.3, 163.5, 142.5, 139.1, 133.4, 129.9, 129.4, 128.9, 128.3, 126.6, 126.0, 125.1, 122.0, 112.7, 111.8, 106.9, 105.5, 56.7, 52.5, 46.5, 41.7, 39.6, 20.8.

Dimethyl-1,1-dicyano-2-(3-chlorophenyl)-1,11b-dihydro-2H-pyrido[2,1-a]isoquinoline-3,4-dicarboxylate (**29a** and **29b**):

A solution of dimethyl acetylenedicarboxylate (DMAD) (132 mg, 0.93 mmol) and **28** (146 mg, 0.77 mmol) in dry THF (10 mL) was stirred under an argon atmosphere. To this, isoquinoline **1** (100 mg, 0.77 mmol) was added and the reaction mixture was stirred for 23 h at room temperature. The solvent was then removed under vacuum and the residue, on chromatographic separation on silica gel using hexane-ethyl acetate mixture (85:15) gave the product dimethyl-1,1-dicyano-2-(3-

chlorophenyl)-1,11b-dihydro-2*H*-pyrido[2,1-a]isoquinoline-3,4-dicarboxylate **29a** (51%) and **29b** (15%) as a pale yellow crystalline solids.

Mp.: 124-126 °C.

IR (KBr) ν_{\max} : 2974, 2965, 1737, 1721, 1684, 1558, 1510, 1455, 1379, 1355, 1219, 1202 cm^{-1} .

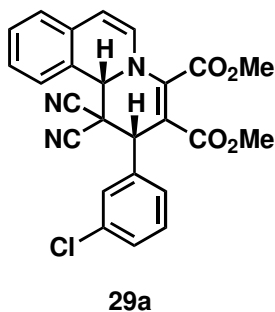

¹H NMR [300 MHz, CDCl₃/CCl₄, 7:3 (v/v)]: δ 7.51 (d, J = 7.91 Hz, 1H), 7.21-7.35 (m, 6H), 7.13 (d, J = 7.67 Hz, 1H), 6.36 (d, J = 7.83 Hz, 1H), 5.75 (d, J = 7.83 Hz, 1H), 5.32 (s, 1H), 4.56 (s, 1H), 4.00 (s, 3H), 3.50 (s, 3H).

¹³C NMR (75 MHz): δ 163.9, 162.5, 145.6, 137.3, 134.9, 130.6, 130.1, 129.4, 128.4, 127.5, 126.0, 125.6, 113.3, 106.5, 63.3, 51.9, 50.7, 29.6.

HRMS: (EI) Calculated for C₂₅H₁₈N₃O₄Cl: 459.0986, Found : 459.0879.

IR (KBr) ν_{\max} : 2976, 2966, 1739, 1723, 1687, 1559, 1515, 1457, 1378, 1359, 1222, 1213 cm^{-1} .

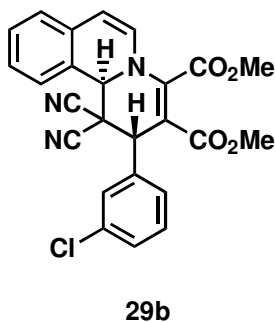

¹H NMR [300 MHz, CDCl₃/CCl₄, 7:3 (v/v)]: δ 7.31 (d, J = 7.81 Hz, 2H), 7.19-7.28 (m, 5H), 7.10 (d, J = 7.8 Hz, 1H), 6.12 (d, J = 7.79 Hz, 1H), 5.71 (d, J = 7.79 Hz, 1H), 5.31 (s, 1H), 4.45 (s, 1H), 3.98 (s, 3H), 3.45 (s, 3H).

¹³C NMR (75 MHz): δ 163.5, 162.1, 144.8, 138.2, 134.5, 130.8, 130.0, 129.3, 128.1, 127.2, 126.3, 125.7, 113.0, 106.4, 63.0, 51.7, 50.7, 29.5.

Dimethyl-1,1-dicyano-2-naphthyl-1,11b-dihydro-2H-pyrido[2,1-a]isoquinoline-3,4-dicarboxylate (31a and 31b):

A solution of dimethyl acetylenedicarboxylate (DMAD) (132 mg, 0.93 mmol) and **30** (158 mg, 0.77 mmol) in dry THF (10 mL) was stirred under an argon atmosphere. To this, isoquinoline **1** (100 mg, 0.77 mmol) was added and the reaction mixture was stirred for 23 h at room temperature. The solvent was then removed under vacuum and the residue, on chromatographic separation on silica gel using hexane-ethyl acetate mixture (85:15) gave the product dimethyl-1,1-dicyano-2-naphthyl-1,11b-dihydro-2H-pyrido[2,1-a]isoquinoline-3,4-dicarboxylate **31a** and **31b** as a pale yellow solid.

Mp.: 131-134 °C.

IR (KBr) ν_{\max} : 3010, 2997, 2221, 1739, 1662, 1601, 1533, 1457, 1396, 1218, 1107 cm^{-1} .

^1H NMR [300 MHz, $\text{CDCl}_3/\text{CCl}_4$, 7:3 (v/v)]: δ 8.32 (d, $J = 8.43$ Hz, 1H), 7.87 (t, $J = 7.88$ Hz, 2H), 7.66-7.46 (m, 5H), 7.36-7.28 (m, 2H), 7.10 (d, $J = 7.43$ Hz, 1H), 6.56 (d, $J = 7.80$ Hz, 1H), 6.12 (d, $J = 7.80$ Hz, 1H), 5.31 (s, 1H), 4.67 (s, 1H), 4.00 (s, 3H), 3.26 (s, 3H).

^{13}C NMR (75 MHz): δ 164.9, 164.0, 144.9, 130.6, 130.4, 129.8, 129.2, 128.8, 127.4, 127.0, 126.8, 126.7, 126.1, 125.9, 125.7, 125.2, 125.0, 124.7, 122.6, 106.4, 106.1, 64.2, 57.5, 53.6, 52.4, 51.8, 44.4, 42.8, 25.6.

HRMS: (EI) Calculated for $\text{C}_{29}\text{H}_{21}\text{N}_3\text{O}_4$: 475.1532, Found : 475.1477.

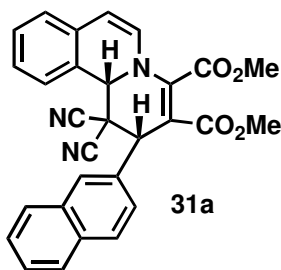

IR (KBr) ν_{\max} : 3013, 3002, 2223, 1741, 1708, 1665, 1607, 1538, 1459, 1408, 1226, 1113 cm^{-1} .

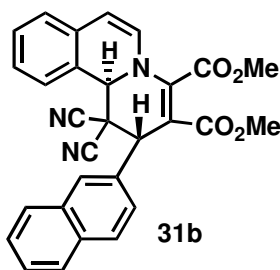

$^1\text{H NMR}$ [300 MHz, $\text{CDCl}_3/\text{CCl}_4$, 7:3 (v/v)]: δ 8.21 (d, $J = 8.01$ Hz, 1H), 7.56 (t, $J = 7.58$ Hz, 2H), 7.53 -7.39 (m, 5H), 7.36-7.28 (m, 2H), 7.00 (d, $J = 7.43$ Hz, 1H), 6.32 (d, $J = 7.77$ Hz, 1H), 5.91 (d, $J = 7.77$ Hz, 1H), 5.25 (s, 1H), 4.33 (s, 1H), 3.98 (s, 3H), 3.24 (s, 3H).

$^{13}\text{C NMR}$ (75 MHz): δ 164.7, 164.2, 144.7, 131.1, 130.2, 129.5, 129.0, 128.5, 127.1, 126.9, 126.8, 126.4, 126.1, 125.8, 125.6, 125.2, 125.0, 124.7, 122.3, 106.0, 105.1, 63.9, 57.2, 53.1, 52.4, 51.8, 44.5, 42.6, 25.2.

Dimethyl-1,1-dicyano-2-(3-nitrophenyl)-1,11b-dihydro-2H-pyrido[2,1-a]isoquinoline-3,4-dicarboxylate (**33a** and **33b**):

A solution of dimethyl acetylenedicarboxylate (DMAD) (132 mg, 0.93 mmol) and **32** (154 mg, 0.77 mmol) in dry THF (10 mL) was stirred under an argon atmosphere. To this, isoquinoline **1** (100 mg, 0.77 mmol) was added and the reaction mixture was stirred for 23 h at room temperature. The solvent was then removed under vacuum and the residue, on chromatographic separation on silica gel using hexane-ethyl acetate mixture (85:15) gave the product dimethyl-1,1-dicyano-2-(3-nitrophenyl)-1,11b-dihydro-2H-pyrido[2,1-a]isoquinoline-3,4-dicarboxylate **33a** (55%) and **33b** (10%) as a pale yellow crystalline solids.

IR (KBr) ν_{max} : 2953, 2236, 1740, 1712, 1645, 1625, 1521, 1440, 1351, 1232 cm^{-1} .

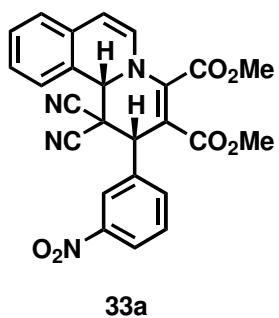

$^1\text{H NMR}$ [300 MHz, $\text{CDCl}_3/\text{CCl}_4$, 7:3 (v/v)]: δ 7.43 (d, $J = 8.15$ Hz, 5H), 7.40-7.31 (m, 2H), 7.29-7.21 (m, 3H), 6.01 (d, $J = 7.82$ Hz, 1H), 5.67 (d, $J = 7.82$ Hz, 1H), 5.35 (s, 1H), 4.55 (s, 1H), 3.94 (s, 3H), 3.52 (s, 3H).

$^{13}\text{C NMR}$ (75 MHz): δ 164.2, 162.4, 155.3, 151.2, 145.8, 144.2, 143.9, 143.0, 142.1, 141.8, 140.8, 139.1, 133.9, 130.1, 128.8,

128.5, 128.4, 128.0, 127.9, 127.0, 125.2, 112.1, 111.8, 109.0, 107.1, 53.6, 51.7, 29.6.

HRMS: (EI) Calculated for C₂₅H₁₈N₄O₆: 470.1226, Found : 470.1438.

IR (KBr) ν_{\max} : 2957, 2241, 1743, 1716, 1609, 1528, 1444, 1358, 1237 cm⁻¹.

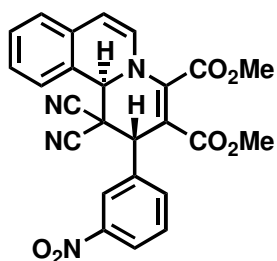

33b

¹H NMR [300 MHz, CDCl₃/CCl₄, 7:3 (v/v)]: δ 7.39 (d, J = 8.1 Hz, 5H), 7.42-7.30 (m, 2H), 7.27-7.21 (m, 3H), 6.02 (d, J = 7.8 Hz, 1H), 5.65 (d, J = 7.8 Hz, 1H), 5.33 (s, 1H), 4.53 (s, 1H), 3.91 (s, 3H), 3.44 (s, 3H).

¹³C NMR (75 MHz): δ 164.5, 163.2, 155.3, 151.2, 145.8, 144.2, 143.9, 143.0, 142.1, 141.8, 140.8, 139.1, 133.9, 130.1, 128.8, 128.5, 128.4, 128.0, 127.9, 127.0, 125.2, 112.1, 111.8, 109.0, 107.1, 53.6, 51.7, 29.6.

Dimethyl-1,1-dicyano-2-(4-fluorophenyl)-1,11b-dihydro-2H-pyrido[2,1-a]isoquinoline-3,4-dicarboxylate (35a and 35b):

A solution of dimethyl acetylenedicarboxylate (DMAD) (132 mg, 0.93 mmol) and **34** (133 mg, 0.77 mmol) in dry THF (10 mL) was stirred under an argon atmosphere. To this, isoquinoline **1** (100 mg, 0.77 mmol) was added and the reaction mixture was stirred for 23 h at room temperature. The solvent was then removed under vacuum and the residue, on chromatographic separation on silica gel using hexane-ethyl acetate mixture (85:15) gave the product dimethyl-1,1-dicyano-2-(4-fluorophenyl)-1,11b-dihydro-2H-pyrido[2,1-a]isoquinoline-3,4-dicarboxylate **35a** (42%) and **35b** as a pale yellow crystalline solids.

Mp.: 119-123 °C.

IR (KBr) ν_{\max} : 3037, 2922, 1748, 1653, 1642, 1473, 1313,

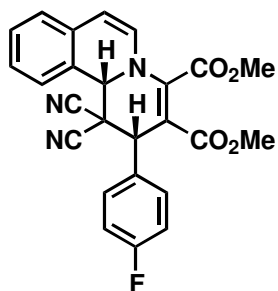

35a

1298, 1212, 1179, 1123 cm^{-1} .

$^1\text{H NMR}$ [300 MHz, $\text{CDCl}_3/\text{CCl}_4$, 7:3 (v/v)]: δ 7.52 (d, $J = 7.40$ Hz, 2H), 7.44-7.32 (m, 4H), 7.11 (d, $J = 8.76$ Hz, 2H), 6.53 (d, $J = 7.93$ Hz, 1H), 6.10 (d, $J = 7.93$ Hz, 1H), 6.02 (s, 1H), 5.29 (s, 1H), 3.92 (s, 3H), 3.42 (s, 3H).

$^{13}\text{C NMR}$ (75 MHz): δ 163.5, 135.5, 134.6, 130.2, 129.3, 127.1, 127.4, 126.1, 114.7, 113.5, 112.2, 110.2, 109.5, 109.0, 108.2, 107.5, 107.2, 106.6, 104.9, 63.3, 53.7, 52.3, 50.9.

HRMS (EI) Calculated for $\text{C}_{25}\text{H}_{18}\text{N}_3\text{O}_4\text{F}$: 443.1266, Found : 443.1296

IR (KBr) ν_{max} : 3039, 2926, 1749, 1707, 1655, 1644, 1475, 1316, 1299, 1215, 1183, cm^{-1} .

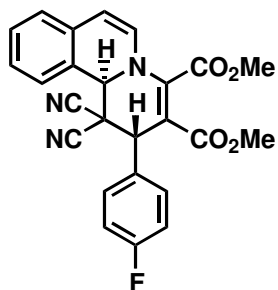

35b

$^1\text{H NMR}$ [300 MHz, $\text{CDCl}_3/\text{CCl}_4$, 7:3 (v/v)]: δ 7.53 (d, $J = 7.49$ Hz, 2H), 7.40-7.31 (m, 4H), 7.26 (m, 2H), 6.55 (d, $J = 7.88$ Hz, 1H), 6.11 (d, $J = 7.88$ Hz, 1H), 6.00 (s, 1H), 5.32 (s, 1H), 5.24 (s, 1H), 3.89 (s, 6H), 3.33 (s, 3H).

$^{13}\text{C NMR}$ (75 MHz): δ 163.2, 162.3, 135.3, 134.2, 131.6, 130.5, 129.1, 126.8, 127.8, 126.6, 114.7, 113.3, 112.0, 111.8, 110.8, 109.7, 109.4, 108.5, 107.5, 107.3, 106.6, 104.7, 63.1, 53.5, 52.1, 50.3.

Dimethyl-1,1-dicyano-2-(4-methoxyphenyl)-1,11b-dihydro-2H-pyrido[2,1-a]isoquinoline-3,4-dicarboxylate (37a):

A solution of dimethyl acetylenedicarboxylate (DMAD) (132 mg, 0.93 mmol) and **36** (143 mg, 0.77 mmol) in dry THF (10 mL) was stirred under an argon atmosphere. To this, isoquinoline **1** (100 mg, 0.77 mmol) was added and the reaction mixture was stirred for 23 h at room temperature. The solvent was then removed under

vacuum and the residue, on chromatographic separation on silica gel using hexane-ethyl acetate mixture (85:15) gave the product dimethyl-1,1-dicyano-2-(4-methoxyphenyl)-1,11b-dihydro-2*H*-pyrido[2,1-*a*]isoquinoline-3,4-dicarboxylate **37a** (53%) as a pale yellow crystalline solids.

Mp.: 119-121 °C.

IR (KBr) ν_{\max} : 2985, 2226, 1743, 1627, 1577, 1513, 1468, 1419, 1362, 1322, 1255 cm^{-1} .

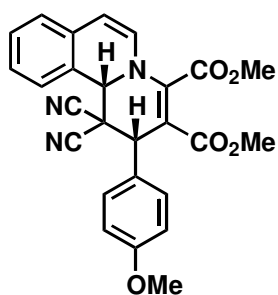

37a

^1H NMR [300 MHz, $\text{CDCl}_3/\text{CCl}_4$, 7:3 (v/v)]: δ 7.52 (d, J = 7.82 Hz 1H), 7.36-7.26 (m, 3H), 7.27 (d, J = 6.91 Hz, 1H) 7.10-6.91 (m, 1H), 6.90-6.89 (m, 2H), 6.37 (d, J = 7.74 Hz, 1H), 5.72 (d, J = 7.89 Hz, 1H), 5.33 (s, 1H), 4.56 (s, 1H), 3.99 (s, 3H), 3.81 (s, 3H), 3.49 (s, 3H).

^{13}C NMR (75 MHz): δ 164.5, 160.2, 130.6, 130.4, 128.5, 127.5, 126.9, 126.0, 118.7, 114.4, 113.9, 113.1, 112.6, 112.3, 111.5, 111.1, 109.9, 109.3, 108.7, 107.9, 106.2, 104.3, 63.4, 55.2, 53.5, 51.9, 50.8, 48.0.

HRMS (EI) Calculated for $\text{C}_{26}\text{H}_{21}\text{N}_3\text{O}_5$: 455.1481, Found : 455.1488.

1,1-Dicyano-2-((*E*)-styryl)-1,11b-dihydro-2*H*-pyrido[2,1-*a*]isoquinoline-3,4-dicarboxylate (**39a**).

A solution of dimethyl acetylenedicarboxylate (DMAD) (132 mg, 0.93 mmol) and **38** (140 mg, 0.77 mmol) in dry THF (10 mL) was stirred under an argon atmosphere. To this, isoquinoline **1** (100 mg, 0.77 mmol) was added and the reaction mixture was stirred for 23 h at room temperature. The solvent was then removed under vacuum and the residue, on chromatographic separation on silica gel using hexane-ethyl acetate mixture (85:15) gave the product 1,1-Dicyano-2-((*E*)-styryl)-1,11b-

dihydro-2*H*-pyrido[2,1-*a*]isoquinoline-3,4-dicarboxylate **39a** (58%) as a pale yellow crystalline solids.

Mp.:149-152 °C.

IR (KBr) ν_{\max} : 3011, 2988, 2218 1735, 1688, 1607, 1603, 1579, 1443, 1378, 1229, 1070 cm^{-1} .

^1H NMR [300 MHz, $\text{CDCl}_3/\text{CCl}_4$, 7:3 (v/v)]: δ 7.78 (m, 2H), 7.51 (m, 3H), 6.61 (d, $J = 14.13$ Hz, 1 H), 6.57 (d, $J = 14.13$ Hz, 1H), 6.39 (d, $J = 7.5$ Hz, 1H), 5.64 (d, $J = 7.5$ Hz, 1H), 5.23 (s, 1 H), 4.72 (s, 1 H), 3.70 (s, 3H), 3.34 (s, 3H).

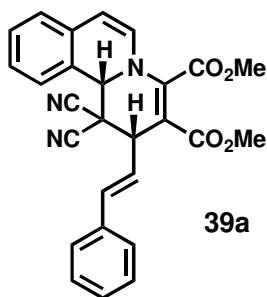

39a

^{13}C NMR (75 MHz): δ 168.1, 163.4, 141.2, 140.8, 135.1, 130.0, 125.8, 127.7, 127.6, 125.5, 114.3, 112.8, 111.9, 100.7, 56.2, 53.4, 51.6, 41.7, 33.2.

HRMS: (EI) Calculated for $\text{C}_{27}\text{H}_{21}\text{N}_3\text{O}_4$: 451.1532, Found : 451.1667.

Dimethyl-1,1-dicyano-2-(4-trifluoromethylphenyl)-1,11b-dihydro-2*H*-pyrido[2,1-*a*]isoquinoline-3,4-dicarboxylate (41a**):**

A solution of dimethyl acetylenedicarboxylate (DMAD) (132 mg, 0.93 mmol) and **40** (172 mg, 0.77 mmol) in dry THF (10 mL) was stirred under an argon atmosphere. To this, isoquinoline **1** (100 mg, 0.77 mmol) was added and the reaction mixture was stirred for 23 h at room temperature. The solvent was then removed under vacuum and the residue, on chromatographic separation on silica gel using hexane-ethyl acetate mixture (85:15) gave the product dimethyl-1,1-dicyano-2-(4-trifluoromethylphenyl)-1,11b-dihydro-2*H*-pyrido[2,1-*a*]isoquinoline-3,4-dicarboxylate **41a** (48%) as a pale yellow crystalline solids.

Mp.:135-139 °C.

IR (KBr) ν_{\max} : 3033, 2973, 2228, 1733, 1657, 1618, 1603, 1579, 1545, 1439, 1428, 1331, 1304, 1218 cm^{-1} .

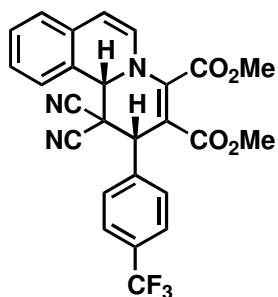

41a

^1H NMR [300 MHz, $\text{CDCl}_3/\text{CCl}_4$, 7:3 (v/v)]: δ 8.16 (d, $J = 7.68$ Hz, 1H), 7.72 (d, $J = 7.9$ Hz, 2H), 7.27 (d, $J = 7.27$ Hz, 1H) 7.26-7.52 (m, 1H), 7.13-7.19 (m, 1H), 7.03-7.10 (m, 2H), 6.29 (d, $J = 7.89$ Hz, 1H), 5.76 (d, $J = 7.89$ Hz, 1H), 5.10 (s, 1H), 4.65 (s, 1H), 3.99 (s, 3H), 3.58 (s, 3H).

^{13}C NMR (75 MHz): δ 164.4, 163.6, 144.2, 140.3, 132.4, 131.7, 130.8, 130.6, 130.2, 128.7, 127.4, 126.1, 126.4, 126.0, 125.9, 122.0, 112.7, 112.0, 109.3, 106.6, 105.7, 105.6, 57.4, 53.7, 47.5, 41.5.

HRMS: (EI) Calculated for $\text{C}_{26}\text{H}_{18}\text{N}_3\text{O}_4\text{F}_3$: 493.1249, Found: 493.1339.

Dimethyl-1,1-dicyano-2-(benzhydryl)-1,11b-dihydro-2H-pyrido[2,1-a]isoquinoline-3,4-dicarboxylate (**43a**):

A solution of dimethyl acetylenedicarboxylate (DMAD) (132 mg, 0.93 mmol) and **42** (189 mg, 0.77 mmol) in dry THF (10 mL) was stirred under an argon atmosphere. To this, isoquinoline **1** (100 mg, 0.77 mmol) was added and the reaction mixture was stirred for 23 h at room temperature. The solvent was then removed under vacuum and the residue, on chromatographic separation on silica gel using hexane-ethyl acetate mixture (85:15) gave the product dimethyl-1,1-dicyano-2-(benzhydryl)-1,11b-dihydro-2H-pyrido[2,1-a]isoquinoline-3,4-dicarboxylate **43a** (43%) as a pale yellow crystalline solid.

IR (KBr) ν_{max} : 3023, 2931, 2238, 1745, 1712, 1667, 1645, 1526, 1492, 1438, 1358, 1233, 1146 cm^{-1} .

^1H NMR [300 MHz, $\text{CDCl}_3/\text{CCl}_4$, 7:3 (v/v)]: δ 7.43 (d, $J = 8.15$ Hz, 4H), 7.40-7.31 (m, 6H), 7.29-7.21 (m, 6H), 6.53 (d, $J = 7.93$ Hz, 2H), 6.10 (d, $J = 7.93$ Hz, 2H), 6.35 (s, 1H), 3.94 (s, 3H), 3.52 (s, 3H).

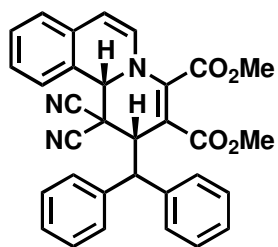

43a

^{13}C NMR (75 MHz): δ 164.2, 162.4, 155.3, 151.2, 145.8, 144.2, 143.9, 143.0, 142.1, 141.8, 140.8, 139.1, 133.9, 130.1, 128.8, 128.5, 128.4, 128.0, 127.9, 127.0, 125.2, 112.1, 111.8, 109.0, 107.1, 53.6, 51.7, 29.6.

4-Anthracen-9-yl-5,5-dicyano-6-*o*-tolyl-1-vinyl-1,4,5,6-tetrahydro-pyridine-2,3-dicarboxylate (45a)

A solution of DMAD (132 mg, 0.93 mmol) and **44** (197 mg, 0.77 mmol) in dry THF (10 mL) was stirred under an argon atmosphere. To this, isoquinoline **1** (100 mg, 0.77 mmol) was added and the reaction mixture was stirred for 23 h at room temperature. The solvent was then removed under vacuum and the residue, on chromatographic separation on silica gel using hexane-ethyl acetate mixture (85:15) gave the product 4-Anthracen-9-yl-5,5-dicyano-6-*o*-tolyl-1-vinyl-1,4,5,6-tetrahydro-pyridine-2,3-dicarboxylate **45a** (29%) as a pale yellow crystalline solid.

IR (KBr) ν_{max} : 2955, 2239, 1742, 1715, 1607, 1526, 1438, 1357, 1236 cm^{-1} .

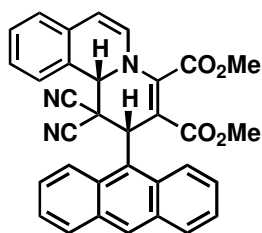

45a

^1H NMR [300 MHz, $\text{CDCl}_3/\text{CCl}_4$, 7:3 (v/v)]: δ 7.43 (d, $J = 8.15$ Hz, 4H), 7.40-7.31 (m, 6H), 7.29-7.21 (m, 6H), 6.91 (s, 1H), 6.35 (s, 1H), 3.94 (s, 3H), 3.52 (s, 3H).

^{13}C NMR (75 MHz): δ 164.2, 162.4, 155.3, 151.2, 145.8, 144.2, 143.9, 143.0, 142.1, 141.8, 140.8, 139.1, 133.9, 130.1, 128.8, 128.5, 128.4, 128.0, 127.9, 127.0, 125.2, 112.1, 111.8, 109.0, 107.1, 53.6, 51.7, 29.6.

1-Cyano-2-(3-nitrophenyl)-1,11b-dihydro-2H-pyrido[2,1-a]isoquinoline-1,3,4-tricarboxylic acid-1-ethyl ester-3,4-dimethyl ester (48).

A solution of DMAD (132 mg, 0.93 mmol) and **47** (191 mg, 0.77 mmol) in dry THF (10 mL) was stirred under an argon atmosphere. To this, isoquinoline **1** (100 mg, 0.77 mmol) was added and the reaction mixture was stirred for 23 h at room temperature. The solvent was then removed under vacuum and the residue, on chromatographic separation on silica gel using hexane-ethyl acetate mixture (85:15) gave the product 1-cyano-2-(3-nitrophenyl)-1,11b-dihydro-2H-pyrido[2,1-a]isoquinoline-1,3,4-tricarboxylic acid-1-ethyl ester-3,4-dimethyl ester **48** (51%) as a pale yellow crystalline solid.

Mp.: 156-159 °C

IR (KBr) ν_{\max} : 3003, 2236, 1740, 1738, 1613, 1563, 1517, 1475, 1439, 1294, 1255, 1204, 1100 cm^{-1} .

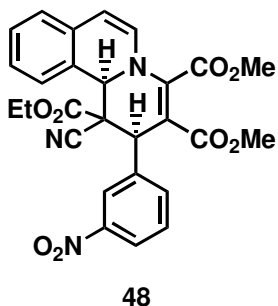

$^1\text{H NMR}$ [300 MHz, $\text{CDCl}_3/\text{CCl}_4$, 7:3 (v/v)]: δ 7.40 (d, $J = 8.25$ Hz, 2H), 7.37-7.30 (m, 4H), 7.29-7.21 (m, 4H), 6.22 (d, $J = 7.21$ Hz, 1H), 5.71 (d, $J = 7.21$ Hz, 1H), 5.36 (s, 1H), 4.51 (s, 1H), 4.42 (uneven quartet, 2H), 3.91 (s, 3H), 3.33 (s, 3H), 1.15 (t, $J = 7.10$ Hz, 3H).

$^{13}\text{C NMR}$ (75 MHz): δ 168.3, 164.2, 162.4, 155.3, 151.2, 145.8, 144.2, 143.9, 143.0, 142.1, 141.8, 140.8, 139.1, 133.9, 130.1, 128.8, 128.5, 128.4, 128.0, 127.9, 127.0, 125.2, 112.1, 111.8, 109.0, 107.1, 61.6, 53.6, 51.7, 29.6.

HRMS: (EI) Calculated for $\text{C}_{27}\text{H}_{23}\text{N}_3\text{O}_8$: 517.4869, Found : 517.5216.

1-Cyano-2-(3-chlorophenyl)-1,11b-dihydro-2H-pyrido[2,1-a]isoquinoline-1,3,4-tricarboxylic acid-1-ethyl ester-3,4-dimethyl ester (50).

A solution of DMAD (132 mg, 0.93 mmol) and **49** (183 mg, 0.77 mmol) in dry THF (10 mL) was stirred under an argon atmosphere. To this, isoquinoline **1** (100 mg, 0.77 mmol) was added and the reaction mixture was stirred for 23 h at room temperature. The solvent was then removed under vacuum and the residue, on chromatographic separation on silica gel using hexane-ethyl acetate mixture (85:15) gave the product 2-(3-chlorophenyl)-1-cyano-1,11b-dihydro-2H-pyrido[2,1-a]isoquinoline-1,3,4-tricarboxylic acid-1-ethyl ester-3,4-dimethyl ester **50** (46%) as a pale yellow crystalline solid.

IR (KBr) ν_{\max} : 2953, 2250, 1744, 1738, 1511, 1439, 1367, 1288, 1232, 1120, 1041, 1009, 817 cm^{-1} .

^1H NMR [300 MHz, $\text{CDCl}_3/\text{CCl}_4$, 7:3 (v/v)]: δ 7.51 (d, $J = 7.91$ Hz, 1H), 7.21-7.34 (m, 6H), 7.13 (d, $J = 7.67$ Hz, 1H), 6.36 (d, $J = 7.83$ Hz, 1H), 5.75 (d, $J = 7.83$ Hz, 1H), 5.32 (s, 1H), 4.28 (t, 2H), 4.56 (s, 1H), 4.00 (s, 3H), 3.50 (s, 3H), 0.98 (t, $J = 7.10$ Hz, 3H).

^{13}C NMR (75 MHz): δ 163.7, 161.6, 153.9, 150.5, 147.6, 145.4, 144.3, 142.6, 142.1, 141.8, 140.8, 137.9, 133.3, 132.4, 129.7, 128.8, 128.5, 128.4, 127.9, 127.0, 125.2, 112.7, 1124.8, 111.1, 109.3, 61.7, 54.5, 52.9, 29.5

HRMS: (EI) Calculated for $\text{C}_{27}\text{H}_{23}\text{ClN}_2\text{O}_6$: 506.4869, Found: 506.4873.

1-Cyano-2-(4-fluorophenyl)-1,11b-dihydro-2H-pyrido[2,1-a]isoquinoline-1,3,4-tricarboxylic acid-1-ethyl ester-3,4-dimethyl ester (52).

A solution of DMAD (132 mg, 0.93 mmol) and **51** (170 mg, 0.77 mmol) in dry THF (10 mL) was stirred under an argon atmosphere. To this, isoquinoline **1** (100 mg,

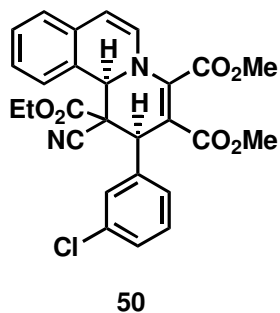

0.77 mmol) was added and the reaction mixture was stirred for 23 h at room temperature. The solvent was then removed under vacuum and the residue, on chromatographic separation on silica gel using hexane-ethyl acetate mixture (85:15) mixture gave the product 1-cyano-2-(4-fluorophenyl)-1,11b-dihydro-2*H*-pyrido[2,1-*a*]isoquinoline-1,3,4-tricarboxylic acid-1-ethyl ester-3,4-dimethyl ester **52** (33%) as a pale yellow crystalline solid.

IR (KBr) ν_{\max} : 2237, 1743, 1545, 1362, 1260, 1070, 820, 736 cm^{-1} .

^1H NMR [300 MHz, $\text{CDCl}_3/\text{CCl}_4$, 7:3 (v/v)]: δ 7.37-7.40 (m, 2H), 7.28-7.35 (m, 2H), 7.02-7.18 (m, 4H), 6.28 (d, $J = 7.89$ Hz, 1H), 5.74 (d, $J = 7.89$ Hz, 1H), 5.10 (s, 1H), 4.58 (s, 1H), 4.12 (m, 2 H), 3.98 (s, 3H), 3.58 (s, 3H), 1.1 (t, $J = 7.31$ Hz, 3H)

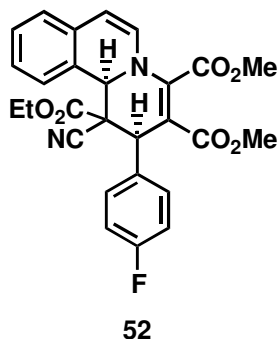

^{13}C NMR (75 MHz): δ 166.3, 164.7, 162.5, 156.1, 154.3, 150.2, 146.7, 145.5, 144.6, 142.8, 142.3, 140.9, 140.3, 139.1, 133.9, 130.1, 128.8, 128.5, 128.4, 128.0, 127.9, 127.0, 125.2, 112.4, 112.2, 110.5, 109.3, 107.1, 55.1, 53.8, 29.4.

HRMS: (EI) Calculated for $\text{C}_{27}\text{H}_{23}\text{FN}_2\text{O}_6$: 490.4798, Found: 490.4873

1-Cyano-2-(4-nitrophenyl)-1,11b-dihydro-2*H*-pyrido[2,1-*a*]isoquinoline-1,3,4-tricarboxylic acid-1-ethyl ester-3,4-dimethyl ester (54**) :**

A solution of DMAD (132 mg, 0.93 mmol) and **53** (191 mg, 0.77 mmol) in dry THF (10 mL) was stirred under an argon atmosphere. To this, isoquinoline **1** (100 mg, 0.77 mmol) was added and the reaction mixture was stirred for 23 h at room temperature. The solvent was then removed under vacuum and the residue, on chromatographic separation on silica gel using hexane-ethyl acetate mixture (85:15) gave the product 1-cyano-2-(4-nitrophenyl)-1,11b-dihydro-2*H*-pyrido[2,1-

a]isoquinoline-1,3,4-tricarboxylic acid-1-ethyl ester-3,4-dimethyl ester **54** (45%) as a pale yellow crystalline solid.

IR (KBr) ν_{\max} : 3056, 1740, 1711, 160, 1258, 1176, 1110, 814 cm^{-1} .

^1H NMR [300 MHz, $\text{CDCl}_3/\text{CCl}_4$, 7:3 (v/v)]: δ 7.31-7.38 (m, 4H), 7.25-7.18 (m, 2H), 7.12 (m, 2H), 6.22 (d, $J = 7.21$ Hz, 1H), 5.71 (d, $J = 7.21$ Hz, 1H), 5.36 (s, 1H), 4.51 (s, 1H), 4.15 (quartet, 2H), 3.91 (s, 3H), 3.33 (s, 3H), 1.12 (t, $J = 7.1$ Hz, 3H).

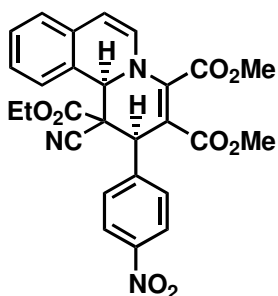

54

^{13}C NMR (75 MHz): δ 166.3, 163.2, 162.8, 153.3, 152.4, 149.7, 146.3, 144.5, 141.7, 143.0, 142.1, 141.5, 140.6, 137.1, 133.4, 132.6, 130.7, 128.8, 128.4, 127.9, 127.0, 125.2, 112.5, 112.1, 109.5, 107.5, 107.1, 55.4, 53.7, 52.4, 29.3.

HRMS: (EI) Calculated for $\text{C}_{27}\text{H}_{23}\text{N}_3\text{O}_8$: 517.4869, Found: 517.4877.

Preparation of Isatilidene Derivatives

A solution of isatin (6.80 mmol) and calcium hydride (27.20 mmol) were taken together in 10 mL of dry DMF. To this the corresponding alkyl halide (22.44 mmol) was added and was refluxed at 55 °C for 12 h. Acidified using concentrated HCl and was worked up in ethyl acetate. The solvent was then removed under vacuum and the residue, on chromatographic separation on silica gel using hexane-ethyl acetate mixture gave the product as a crystalline solid.

A solution of isatin derivative (3.40 mmol), malononitrile (6.80 mmol), and ammonium acetate (3.40 mmol) were taken together in 10 mL of benzene. To this a drop of glacial acetic acid was added and was refluxed for 6 h. The solvent was then

removed and was worked up in dichloromethane. Recrystallized from petroleum ether-dichloromethane gave the corresponding isatlidene derivative.

Dimethyl-1,1-dicyano-1,1',2',11b-tetrahydro-1'-methyl-2'-oxospiro[2*H*-benzo[*a*]quinolizine-2,3'-[3*H*]indole]-3,4-dicarboxylate (59**)**

A solution of DMAD (132 mg, 0.930 mmol) and **58** (159 mg, 0.77 mmol) in dry THF (10 mL) was stirred under an argon atmosphere. To this, isoquinoline **1** (100 mg, 0.77 mmol) was added and the reaction mixture was stirred for 12 h at room temperature. The solvent was then removed under vacuum and the residue, on chromatographic separation on silica gel using hexane-ethyl acetate mixture (85:15) gave the product Dimethyl-1,1-dicyano-1,1',2',11b-tetrahydro-1'-methyl-2'-oxospiro[2*H*-benzo[*a*]quinolizine-2,3'-[3*H*]indole]-3,4-dicarboxylate **59** (48%) as a pale yellow crystalline solid.

Mp.: 135-137 °C.

IR (KBr) ν_{\max} : 3031, 2928, 2252, 1745, 1714, 1679, 1548, 1540, 1429, 1412, 1277, 1118 cm^{-1} .

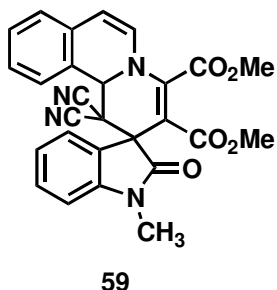

¹H NMR [300 MHz, $\text{CDCl}_3/\text{CCl}_4$, 7:3 (v/v)]: δ 7.51 (d, $J = 7.3$ Hz, 1H), 7.37 (t, $J = 7.71$ Hz, 1H), 7.09 (t, $J = 7.6$ Hz, 1H), 6.85 (d, $J = 7.8$ Hz, 1H), 6.41 (d, $J = 7.27$ Hz, 1H), 6.37 (s, 1H), 5.55 (d, $J = 7.27$ Hz, 1H), 3.98 (s, 3H), 3.41 (s, 3H), 3.29 (s, 3H).

¹³C NMR (75 MHz): δ 164.2, 163.6, 159.7, 147.8, 145.2, 144.3, 141.5, 135.3, 133.1, 132.5, 131.3, 128.7, 128.2, 127.6, 126.3, 125.5, 124.3, 120.4, 119.8, 117.5, 115.8, 111.9, 111.5, 101.7, 67.5, 56.2, 53.1, 52.7, 51.9.

HRMS: (EI) Calculated for $\text{C}_{28}\text{H}_{24}\text{N}_4\text{O}_5$: 496.1747, Found 496.1745.

Dimethyl-1,1-dicyano-1,1',2',11b-tetrahydro-1'-benzyl-2'-oxospiro[2H-benzo[a]quinolizine-2,3'-[3H]indole]-3,4-dicarboxylate (61)

A solution of DMAD (132 mg, 0.93 mmol) and **60** (221 mg, 0.77 mmol) in dry THF (10 mL) was stirred under an argon atmosphere. To this, isoquinoline **1** (100 mg, 0.77 mmol) was added and the reaction mixture was stirred for 12 h at room temperature. The solvent was then removed under vacuum and the residue, on chromatographic separation on silica gel using hexane-ethyl acetate mixture (85:15) gave the product dimethyl-1,1-dicyano-1,1',2',11b-tetrahydro-1'-benzyl-2'-oxospiro[2H-benzo[a]quinolizine-2,3'-[3H]indole]-3,4-dicarboxylate **61** (39%) as a pale yellow crystalline solid.

Mp.: 141-143 °C.

IR (KBr) ν_{\max} : 2958, 2924, 2226, 1729, 1715, 1619, 1576, 1408, 1366, 1222 cm^{-1} .

^1H NMR [300 MHz, $\text{CDCl}_3/\text{CCl}_4$, 7:3 (v/v)]: δ 7.49 (d, $J = 6.99$ Hz, 2H), 7.42-7.28 (m, 7H), 7.26-7.11 (m, 3H), 6.94 (d, $J = 7.99$ Hz, 1H), 6.36 (d, $J = 7.91$ Hz, 1H), 5.82 (d, $J = 7.91$ Hz, 1H), 5.65 (s, 1H), 4.01 (s, 3H), 3.39 (s, 3H).

^{13}C NMR (75 MHz): δ 174.9, 164.2, 163.6, 144.2, 132.6, 129.7, 129.6, 129.1, 128.7, 128.7, 127.5, 127.3, 126.9, 124.6, 123.6, 116.3, 115.6, 114.3, 112.5, 109.9, 105.3, 105.1, 63.4, 60.3, 57.9, 54.3, 53.3, 52.0, 29.7, 27.1, 22.7, 21.0, 13.4.

HRMS: (EI) Calculated for $\text{C}_{34}\text{H}_{28}\text{N}_4\text{O}_5$: 572.6101, Found 572.6145.

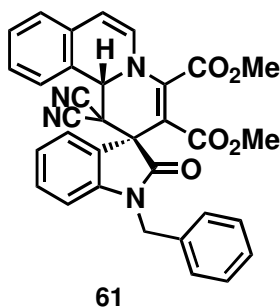

Dimethyl-1,1-dicyano-1,1',2',11b-tetrahydro-1'-allyl-2'-oxospiro[2H-benzo[a]quinolizine-2,3'-[3H]indole]-3,4-dicarboxylate (63)

A solution of DMAD (132 mg, 0.93 mmol) and **62** (182 mg, 0.77 mmol) in dry THF (10 mL) was stirred under an argon atmosphere. To this, isoquinoline **1** (100 mg, 0.77 mmol) was added and the reaction mixture was stirred for 12 h at room temperature. The solvent was then removed under vacuum and the residue, on chromatographic separation on silica gel using hexane-ethyl acetate mixture (85:15) gave the product dimethyl-1,1-dicyano-1,1',2',11b-tetrahydro-1'-allyl-2'-oxospiro[2H-benzo[a]quinolizine-2,3'-[3H]indole]-3,4-dicarboxylate **63** (61%) as a pale yellow crystalline solid.

Mp.: 141-143 °C.

IR (KBr) ν_{\max} : 2931, 2927, 2228, 2221, 1733, 1688, 1521, 1501, 1473, 1428, 1321, 1277 cm^{-1} .

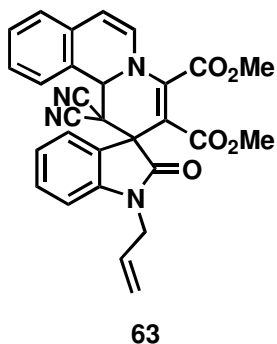

^1H NMR [300 MHz, $\text{CDCl}_3/\text{CCl}_4$, 7:3 (v/v)]: δ 7.47 (d, J = 7.6 Hz, 1H), 7.38 (t, J = 7.7 Hz, 1H), 7.07 (t, J = 7.6 Hz, 1H), 6.87 (d, J = 7.81 Hz, 1H), 6.31 (d, J = 7.53 Hz, 1H), 5.71- 5.80 (m, 1H), 5.23- 5.38 (m, 2H), 4.45 (uneven t, 2H), 3.87 (s, 3H), 3.48 (s, 3H).

^{13}C NMR (75 MHz): δ 167.9, 165.7, 148.6, 145.8, 142.3, 133.5, 132.3, 131.1, 129.0, 127.2, 126.4, 125.1, 120.7, 120.3, 118.5, 114.7, 112.3, 111.7, 100.2, 65.9, 61.2, 52.89, 52.31, 50.85.

HRMS: (EI) Calculated for $\text{C}_{30}\text{H}_{26}\text{N}_4\text{O}_5$: 522.5514, Found: 522.5671.

Dimethyl-1,1-dicyano-1,1',2',11b-tetrahydro-1'-ethyl-2'-oxospiro[2H-benzo[a]quinolizine-2,3'-[3H]indole]-3,4-dicarboxylate (65)

A solution of DMAD (132 mg, 0.93 mmol) and **64** (173 mg, 0.77 mmol) in dry THF (10 mL) was stirred under an argon atmosphere. To this, isoquinoline **1** (100 mg, 0.77 mmol) was added and the reaction mixture was stirred for 12 h at room temperature. The solvent was then removed under vacuum and the residue, on chromatographic separation on silica gel using hexane-ethyl acetate mixture (85:15) gave the product dimethyl-1,1-dicyano-1,1',2',11b-tetrahydro-1'-ethyl-2'-oxospiro[2H-benzo[a]quinolizine-2,3'-[3H]indole]-3,4-dicarboxylate **65** (54%) as a pale yellow crystalline solid.

Mp.: 159-163 °C.

IR (KBr) ν_{\max} : 3011, 2904, 2231, 1729, 1709, 1623, 1545, 1417, 1345, 1267, 1187, 1013 cm^{-1} .

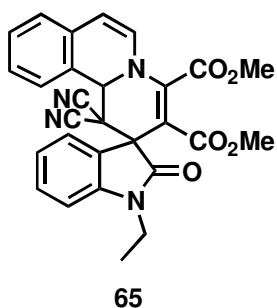

^1H NMR [300 MHz, $\text{CDCl}_3/\text{CCl}_4$, 7:3 (v/v)]: δ 7.51-7.55 (m, 5H), 7.16-7.29 (m, 3H), 6.21 (d, $J = 7.23$ Hz, 1H), 5.69 (d, $J = 7.23$ Hz, 1H), 5.19 (s, 1H), 4.38 (t, $J = 7.52$ Hz, 2H), 3.81 (s, 3H), 3.53 (s, 3H), 1.37 (q, 3H).

^{13}C NMR (75 MHz): δ 167.3, 165.5, 161.4, 146.7, 144.0, 141.2, 132.7, 131.6, 131.0, 129.5, 127.3, 126.2, 125.3, 124.4, 120.8, 119.6, 115.9, 114.2, 112.3, 112.1, 100.7, 66.5, 56.6, 53.4, 52.8, 52.1, 49.6, 41.1, 17.7.

HRMS: (EI) Calculated for $\text{C}_{29}\text{H}_{26}\text{N}_4\text{O}_5$: 510.1901, Found 510.1945.

Dimethyl 5'-bromo-1,1-dicyano-1,1',2',11b-tetrahydro-1'-methyl-2'-oxospiro[2H-benzo[a]quinolizine-2,3'-[3H]indole]-3,4-dicarboxylate (67)

A solution of DMAD (132 mg, 0.93 mmol) and **66** (222 mg, 0.77 mmol) in dry THF (10 mL) was stirred under an argon atmosphere. To this, isoquinoline **1** (100 mg,

0.77 mmol) was added and the reaction mixture was stirred for 12 h at room temperature. The solvent was then removed under vacuum and the residue, on chromatographic separation on silica gel using hexane-ethyl acetate mixture (85:15) gave the product dimethyl 5'-bromo-1,1-dicyano-1,1',2',11b-tetrahydro-1'-methyl-2'-oxospiro[2*H*-benzo[*a*]quinolizine-2,3'-[3*H*]indole]-3,4-dicarboxylate **67** (45%) as a pale yellow crystalline solid.

Mp.: 156-158 °C.

IR (KBr) ν_{\max} : 2957, 2952, 2235, 1738, 1652, 1601, 1528, 1433, 1343, 1302, 1279, 1129 cm^{-1} .

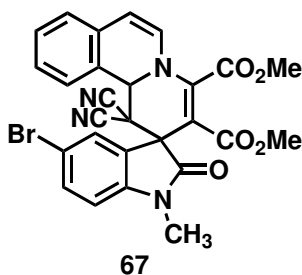

$^1\text{H NMR}$ [300 MHz, $\text{CDCl}_3/\text{CCl}_4$, 7:3 (v/v)]: δ 8.21 (d, $J = 8.12$ Hz, 2H), 8.00 (d, $J = 8.09$ Hz, 2H), 7.42-7.28 (m, 7H), 7.26-7.11 (m, 3H), 6.94 (d, $J = 7.99$ Hz, 1H), 6.36 (d, $J = 7.91$ Hz, 1H), 5.82 (d, $J = 7.91$ Hz, 1H), 5.65 (s, 1H), 3.77 (s, 3H), 3.64 (s, 3H).

$^{13}\text{C NMR}$ (75 MHz): δ 167.5, 165.9, 148.2, 144.7, 143.7, 142.3, 137.2, 135.3, 132.3, 129.8, 128.4, 126.4, 125.6, 123.7, 120.8, 119.4, 114.6, 112.0, 111.9, 101.2, 65.9, 62.2, 52.71, 52.11, 50.74.

Dimethyl 5'-bromo-1,1-dicyano-1,1',2',11b-tetrahydro-1'-allyl-2'-oxospiro[2*H*-benzo[*a*]quinolizine-2,3'-[3*H*]indole]-3,4-dicarboxylate (69**)**

A solution of DMAD (132 mg, 0.93 mmol) and **68** (243 mg, 0.77 mmol) in dry THF (10 mL) was stirred under an argon atmosphere. To this, isoquinoline **1** (100 mg, 0.77 mmol) was added and the reaction mixture was stirred for 12 h at room temperature. The solvent was then removed under vacuum and the residue, on chromatographic separation on silica gel using hexane-ethyl acetate mixture (85:15) gave the product **69** dimethyl 5'-bromo-1,1-dicyano-1,1',2',11b-tetrahydro-1'-allyl-2'-

oxospiro[2*H*-benzo[*a*]quinolizine-2,3'-[3*H*]indole]-3,4-dicarboxylate (42%) as a pale yellow crystalline solid.

Mp.: 175-177 °C

IR (KBr) ν_{\max} : 3030, 2960, 2851, 2231, 1729, 1589, 1548, 1486, 1362, 1263, 1186, 1020 cm^{-1} .

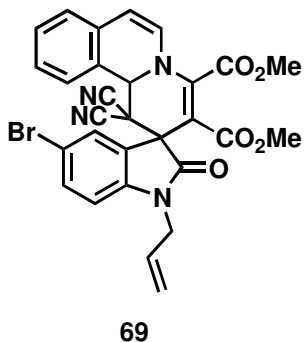

^1H NMR [300 MHz, $\text{CDCl}_3/\text{CCl}_4$, 7:3 (v/v)]: δ 7.42 (d, J = 7.54 Hz, 1H), 7.32 (t, J = 7.87 Hz, 1H), 7.27 (t, J = 7.55 Hz, 1H), 6.77 (d, J = 7.87 Hz, 1H), 6.37 (d, J = 7.39 Hz, 1H), 5.71- 5.80 (m, 1H), 5.23-5.38 (m, 2H), 4.45 (uneven t, 2H), 3.87 (s, 3H), 3.47(s, 3H).

^{13}C NMR (75 MHz): δ 167.9, 165.7, 148.6, 145.8, 142.3, 133.5, 132.3, 131.1, 129.0, 127.2, 126.4, 125.1, 120.7, 120.3, 118.5, 114.7, 112.3, 111.7, 100.2, 65.9, 61.2, 52.89, 52.31, 50.85.

Dimethyl- 5'-bromo-1,1-dicyano-1,1',2',11b-tetrahydro-1'-benzyl-2'-oxospiro[2*H*-benzo[*a*]quinolizine-2,3'-[3*H*]indole]-3,4-dicarboxylate (71)

A solution of DMAD (132 mg, 0.93 mmol) and **70** (282 mg, 0.77 mmol) in dry THF (10 mL) was stirred under an argon atmosphere. To this, isoquinoline **1** (100 mg, 0.77 mmol) was added and the reaction mixture was stirred for 12 h at room temperature. The solvent was then removed under vacuum and the residue, on chromatographic separation on silica gel using hexane-ethyl acetate mixture (85:15) gave the product dimethyl- 5'-bromo-1,1-dicyano-1,1',2',11b-tetrahydro-1'-benzyl-2'-oxospiro[2*H*-benzo[*a*]quinolizine-2,3'-[3*H*]indole]-3,4-dicarboxylate **71** (51%) as a pale yellow crystalline solid.

IR (KBr) ν_{\max} : 2958, 2939, 2234, 1733, 1608, 1588, 1482, 1403, 1372, 1269, 1212, 1188, 1099 cm^{-1} .

^1H NMR [300 MHz, $\text{CDCl}_3/\text{CCl}_4$, 7:3 (v/v)]: δ 7.49 (d, J =

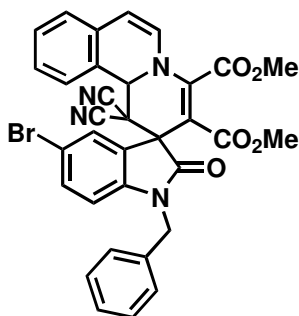

71

6.99 Hz, 2H), 7.42-7.28 (m, 7H), 7.26-7.11 (m, 3H), 6.94 (d, $J = 7.99$ Hz, 1H), 6.36 (d, $J = 7.91$ Hz, 1H), 5.82 (d, $J = 7.91$ Hz, 1H), 5.65 (s, 1H), 4.01 (s, 3H), 3.39 (s, 3H).

^{13}C NMR (75 MHz): δ 174.9, 164.2, 163.6, 144.2, 132.6, 129.7, 129.6, 129.1, 128.7, 128.7, 127.5, 127.3, 126.9, 124.6, 123.6, 116.3, 115.6, 114.3, 112.5, 109.9, 105.3, 105.1, 63.4, 60.3, 57.9, 54.3, 53.3, 52.0, 29.7, 27.1, 22.7, 21.0, 13.4.

2.6 References

- 1) a) Huisgen, R. *Proc. Chem. Soc.* **1961**, 357. b) Huisgen, R. *Angew. Chem., Int. Ed.* **1963**, 2, 633. c) Garner, P.; Ho, W. B.; Grandhee, S. K.; Youngs, W. J.; Kennedy, V. O. *J. Org. Chem.* **1991**, 56, 5893. d) Garner, P.; Ho, W. B.; Shin, C. *J. Am. Chem. Soc.* **1993**, 115, 10742. e) Monn, J. A.; Valli, M. *J. Org. Chem.* **1994**, 59, 2773. f) Fiswick, C. W. G.; Foster, R. J.; Carr, R. E. *Tetrahedron Lett.* **1996**, 37, 3915.
- 2) a) Huisgen, R. in *Topics in Heterocyclic Chemistry*; Castle, R.; Ed; John Wiley and sons: New York, 1969, Chapter 8, 223. b) Huisgen, R. *Ger. Z. Chem.* **1968**, 8, 290.
- 3) Domling, A.; Ugi, I. *Angew. Chem., Int. Ed.* **2000**, 39, 3168.
- 4) Huisgen, R.; Morikawa, M.; Herbig, K.; Brunn, E. *Chem. Ber.* **1967**, 100, 1094.
- 5) a) Acheson, R. M.; Stubbs, J. K. *J. Chem. Soc. C*, **1971**, 32, 3285. b) Acheson, R. M.; Hole, F. *J. Chem. Soc.* **1962**, 748.
- 6) Huisgen, R.; Herbig, K. *Liebigs Ann. Chem.* **1965**, 688, 98.
- 7) Nair, V.; Sreekanth, A. R.; Abhilash, N.; Bhadbhade, M. M.; Gonnade, R. C. *Org. Lett.* **2002**, 4, 3575.
- 8) Nair, V.; Sreekanth, A. R.; Biju A. T.; Rath, N. P. *Tetrahedron Lett.* **2003**, 44, 729.

-
- 9) Mironov, M. A.; Mokrushin, V. S.; Maltsev, S. S. *Synlett* **2003**, 943.
- 10) Nair, V.; Menon, R. S.; Beneesh, P. B.; Sreekumar, V.; Bindu, S. *Org. Lett.* **2004**, 6, 767.
- 11) Nair, V.; Beneesh, P. B.; Sreekumar, V.; Bindu, S.; Menon, R. S.; Deepthi, A. *Tetrahedron. Lett.* **2005**, 46, 201.

A Facile Synthesis of Pyridobenzothiazole Derivatives *via* 1,4-Dipolar Cycloaddition Reaction of Benzothiazole-Dimethyl Acetylenedicarboxylate Zwitterion with Arylidenemalononitriles

3.1 Introduction

Prompted by the success in developing a synthesis of tetrahydrobenzoquinolizine derivatives and oxindolinylidene derivatives by the reaction of arylidenemalononitriles and isatilidenes with 1,4-dipoles generated from isoquinoline and DMAD (see chapter 2), it was reasoned that a similar reaction would occur in the case of benzothiazole-DMAD zwitterion with arylidenemalononitriles. The results of our investigations, validating the assumption are presented in this chapter.

In 1975 Abbott *et al.* had studied the reactivity of benzothiazole towards acetylenic ester. This reaction afforded the 1:2 adduct. Their investigations indicated that the reaction proceeded *via* the intermediacy of the 1,4-dipole generated from benzothiazole and DMAD¹ (see also chapter 1).

Investigations by Ogura *et al.* have shown that if water is present in the reaction medium, product **6** is formed; this can be explained by invoking a mechanistic pathway as shown in the following scheme.²

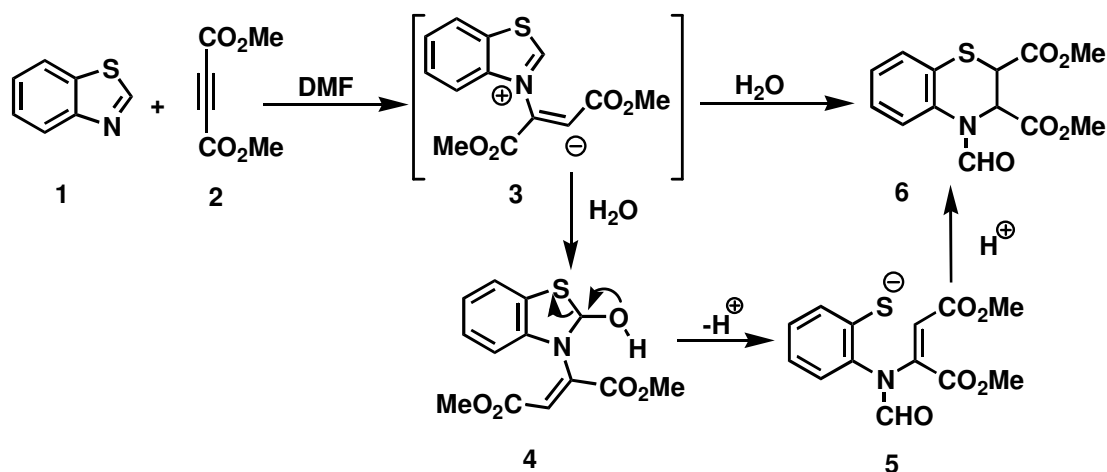

Scheme 3.1

3.2 Background to the Present Work

Recently, studies in our laboratory have shown that the 1,4-dipolar intermediate generated by the addition of benzothiazole **1** to DMAD **2** undergoes a facile reaction with electrophiles like aldehydes to afford oxazinobenzothiazole derivatives **8** in good yields thereby constituting a novel multicomponent reaction. A typical example is shown in Scheme 3. 2.³

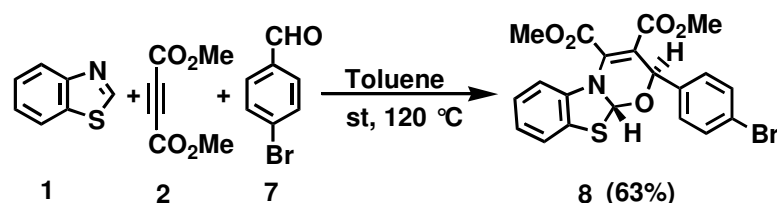

Scheme 3. 2

3.3 Statement of the Problem

It was evident from the literature survey that most of the zwitterionic intermediates investigated were generated by the addition of heterocyclic nucleophiles having a single heteroatom such as pyridine and isoquinoline to acetylenic esters.

Hence it was of interest to undertake an investigation of the reactivity of zwitterions formed by the addition of nucleophiles having more than one heteroatom in the ring. For this purpose we chose benzothiazole as the nucleophile. The results of our studies involving the 1:1 zwitterionic intermediate from benzothiazole and DMAD with dicyanostyrenes leading to the novel synthesis of functionalized pyridobenzothiazole derivatives are presented here.

3.4 Results and Discussion

The dicyanostyrenes (arylidene malononitriles) were prepared by the condensation of aromatic aldehydes with malononitrile in presence of ammonium acetate and trace amount of acetic acid at 60 °C in benzene for 6 h (see also chapter 2).

3.4a Reaction of Benzothiazole and DMAD with Arylidene malononitriles.

Our investigations were initiated by treating arylidene malononitrile **9** with DMAD and benzothiazole **1** in anhydrous toluene in a sealed tube at 110° C for 12 h. Removal of solvent under vacuum followed by chromatographic separation of the reaction mixture afforded the diastereomeric mixture of pyridobenzothiazole derivative 8,8-dicyano-2-eth-(E)-ylidene-3-prop-2-en-(E)-ylidene-7-*p*-tolyl-2,3,8,8a-tetrahydro-7*H*-thiazolo[3,2-*a*]pyridine-5,6-dicarboxylic acid dimethyl ester **10a** and **10b** as a yellow solids (81%) in 1:1 diastereomeric ratio (Scheme 3.3). The major diastereoisomer **10a** was separated using HPLC.

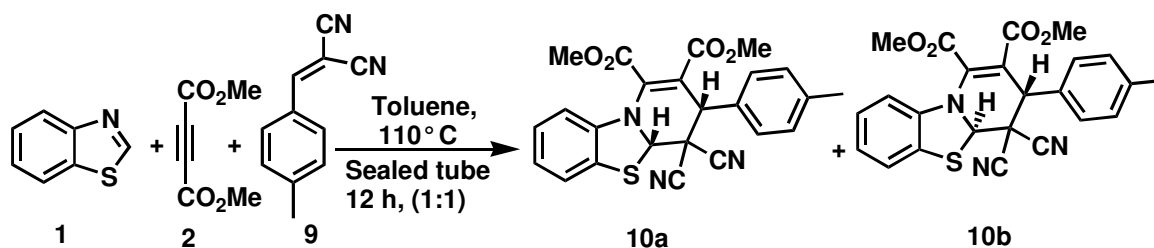

Scheme 3.3

The structure of the product **10a** was elucidated by spectroscopic techniques. In the IR spectrum of **10a**, the absorption at 2254 cm^{-1} can be attributed to the cyano group and a sharp band at 1745 and 1710 cm^{-1} was assigned to the ester carbonyl group. The ^1H NMR spectrum displayed two methoxy groups as singlets at δ 4.03 and 3.49, the benzylic proton was seen as a singlet at δ 4.50 and the ring junction proton resonated at δ 5.69 as a singlet. In the ^{13}C NMR spectrum, the two cyano groups resonated at δ 111.5 and 111.9. The two ester carbonyls were seen at δ 164.2 and 163.6. All other signals were also in good agreement with the assigned structure. The compound gave satisfactory HRMS analysis also.

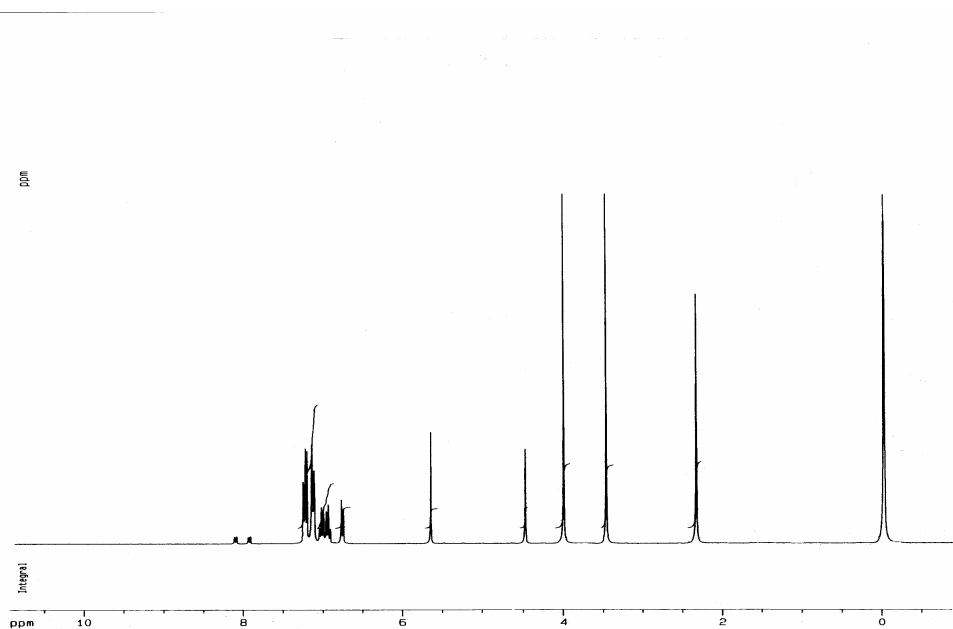

Figure 3.1: ^1H NMR spectrum of **10a**.

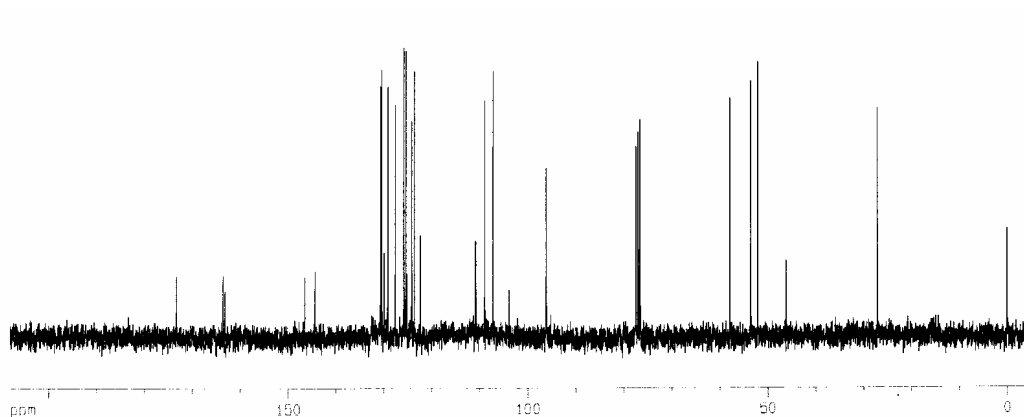

Figure 3.2: ^{13}C NMR spectrum of **10a**.

The major diastereoisomer **10a** was separated using HPLC and its stereochemistry was established by ^1H nOe difference spectroscopic studies (Figure 3.4). It was assigned *cis* stereochemistry since selective irradiation of H_a produced enhancements (8.85%) in the signals corresponding to H_b (Figure 3.3).

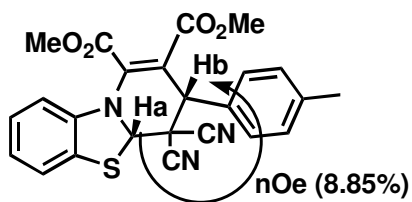

Figure 3.3: Selected nOe correlations for the major diastereoisomer **10a**.

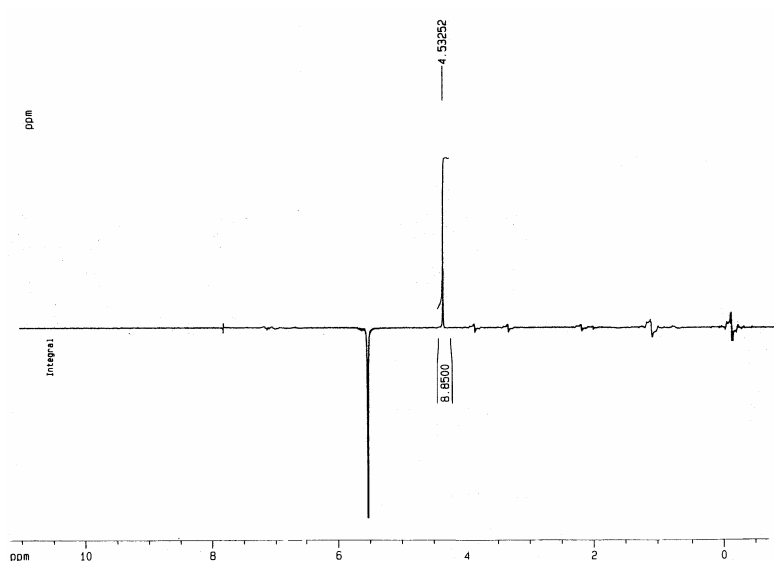
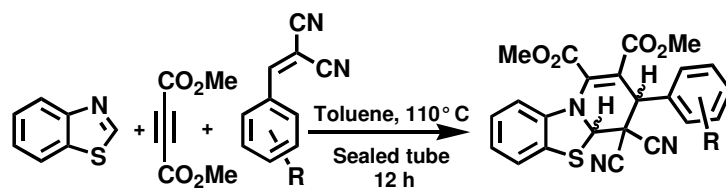

Figure 3.4: Enhancement of signal H_b due to H_a

To explore the generality and scope of this process, similar substrates were subjected to the reaction under identical conditions. The results obtained are presented in table 3.1.

Table 3.1. Reaction of benzothiazole and DMAD with arylidenemalononitriles

Entry	Styrene	Product	Diastereomeric ratio (cis:trans) ^a	Yield (%)
1			6:1	73
2			1.8:1	62
3			1.2:1	55
4			1.7:1	75
5			2:1	69
6			1:1	41

^a Ratio determined from ¹H NMR

In all cases, the compounds were completely characterized and their structures were established by spectroscopic methods.

3.5 Mechanistic Considerations

The reaction involves the initial formation of the 1:1 zwitterionic intermediate between benzothiazole **1** and DMAD **2**, which adds to the electrophilic double bond of dicyanostyrenes leading to another dipolar species. Cyclization of the latter leads to the formation of the product **24** (Scheme 3.4).

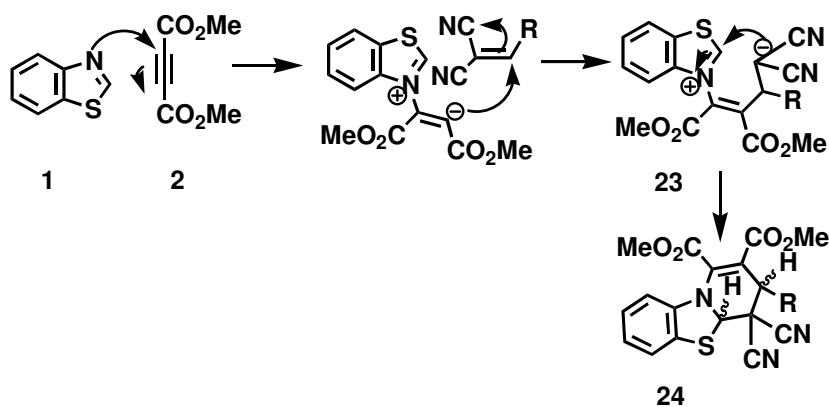

Scheme 3.4

3.6 Conclusion

In conclusion, we have observed a novel three component condensation reaction that offers an easy and one-pot entry to the synthesis of various pyrido benzothiazole derivatives *via* the 1,4-dipolar cycloaddition reactions of the zwitterions generated from benzothiazole and DMAD with activated styrenes.

3.7 Experimental Details

General

General information about the experiments is given in section 2. 5.

General Procedure for the Synthesis of Pyridobenzothiazole Derivatives

Benzothiazole (1 mmol), DMAD (1.2 mmol) and dicyanostyrene (1 mmol) were taken in anhydrous toluene (2 mL) in a sealed tube. It was evacuated, sealed and then heated at 110 °C for 12 h. The reaction mixture was cooled and the solvent was removed in vacuo on a rotary evaporator. The residue on purification by column chromatography using neutral alumina and 15% ethyl acetate-hexane mixture as the eluent, afforded the diastereomeric mixture of the product.

1,1-Dicyano-2-*p*-tolyl-1,9a-dihydro-2*H*-9-thia-4a-aza-fluorene-3,4-dicarboxylic acid dimethyl ester (10a & 10b).

Following the general procedure, with benzothiazole 1, DMAD and 4-methylphenyldicyanostyrene, the diastereomeric mixture of the product 1,1-Dicyano-2-*p*-tolyl-1,9a-dihydro-2*H*-9-thia-4a-aza-fluorene-3,4-dicarboxylic acid dimethyl ester **10a & 10b** was obtained as a yellow solid in 81% yield.

IR (KBr) ν_{\max} : 3015, 2254, 1745, 1710, 1591, 1566, 1492, 1279, 1137, 1056, 987 cm^{-1} .

^1H NMR [300 MHz, $\text{CDCl}_3/\text{CCl}_4$, 7:3 (v/v)]: δ 2.29 (s, 3H), 2.31 (s, 2.3H), 3.49 (s, 3H), 3.63 (s, 2.28H), 3.83 (s, 3H), 4.03 (s, 2.57H), 4.50 (s, 1.7H), 5.69 (s, 0.75H), 5.74 (s, 0.89H), 6.80 (d, $J = 8.1$ Hz, 1.9H), 7.01-7.12 (m, 4H), 7.20-7.27 (m, 6H), 7.47-7.55 (m, 1.5H).

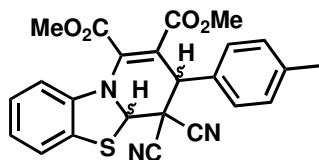

10a & 10b

^{13}C NMR (75 MHz): δ 164.2, 163.6, 130.1, 129.6, 129.3, 128.5, 127.9, 127.6, 127.5, 124.9, 122.0, 111.9, 111.5, 110.6, 105.7, 105.3, 52.3, 51.9, 21.5, 21.2.

HRMS (EI) Calcd. for $C_{24}H_{19}N_3O_4S$: 445.1096, Found: 445.1067.

2-(3-Chlorophenyl)-1,1-dicyano-1,9a-dihydro-2H-9-thia-4a-aza-fluorene-3,4-dicarboxylic acid dimethyl ester (17a & 17b).

Following the general procedure, with benzothiazole **1**, DMAD and 3-chlorophenyldicyanostyrene, the diastereomeric mixture of the product 2-(3-Chlorophenyl)-1,1-dicyano-1,9a-dihydro-2H-9-thia-4a-aza-fluorene-3,4-dicarboxylic acid dimethyl ester **17a & 17b** was obtained as a yellow solid in 73% yield.

IR (KBr) ν_{\max} : 2951, 2217, 1730, 1701, 1670, 1608, 1491, 1456, 1435, 1379, 1361, 1315, 1285, 1220, 1192, 1109, 1083, 1053, 1022, 1005, 966 cm^{-1} .

1H NMR [300 MHz, $CDCl_3/CCl_4$, 7:3 (v/v)]: δ 3.60 (s, 3H), 3.62 (s, 0.5H), 3.81 (s, 3H), 3.88 (s, 0.65H), 4.67 (s, 1.6H), 5.53 (s, 0.4H), 5.92 (s, 0.6H), 6.91-6.97 (d, $J = 7.77$ Hz, 1.13H), 7.01-7.12 (m, 3.9H), 7.24-7.36 (m, 4.26H), 7.47 (s, 1.34H), 7.48 (d, $J = 8.1$ Hz, 0.89H), 7.72 (d, $J = 8.2$ Hz, 2H).

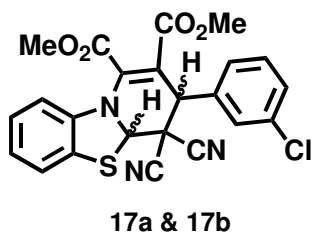

^{13}C NMR (75 MHz): δ 164.3, 162.8, 145.9, 137.6, 136.5, 134.2, 130.0, 129.7, 129.4, 129.3, 129.1, 128.6, 127.8, 127.2, 126.8, 126.5, 125.4, 125.7, 123.7, 116.3, 113.4, 112.1, 110.3, 106.1.

HRMS (EI) Calcd. for $C_{23}H_{16}ClN_3O_4S$: 465.0550, Found: 465.0564.

1,1-Dicyano-2-(3-nitrophenyl)-1,9a-dihydro-2H-9-thia-4a-aza-fluorene-3,4-dicarboxylic acid dimethyl ester (18a & 18b).

Following the general procedure, with benzothiazole **1**, DMAD and 3-nitrophenyldicyanostyrene, the diastereomeric mixture of the product 1,1-dicyano-2-(3-nitrophenyl)-1,9a-dihydro-2H-9-thia-4a-aza-fluorene-3,4-dicarboxylic acid dimethyl ester **18a & 18b** was obtained as a yellow solid in 62% yield.

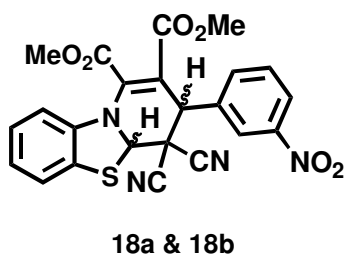

IR (KBr) ν_{\max} : 3064, 2924, 2220, 1728, 1703, 1585, 1435, 1346, 1267, 1207, 1161, 1091, 1014, 962 cm^{-1} .

^1H NMR [300 MHz, $\text{CDCl}_3/\text{CCl}_4$, 7:3 (v/v)]: δ 3.65 (s, 3H), 3.69 (s, 1.6H), 3.83 (s, 3H), 3.89 (s, 1.74H), 4.47 (s, 1.79H), 5.63 (s, 1.62H), 5.71 (s, 0.8H), 5.89 (s, 1.4H), 6.79 (d, $J = 7.6$ Hz, 0.9H), 6.93-6.99 (m, 3H), 7.15 (s, 1H), 7.35 (d, $J = 7.2$ Hz, 1.8H), 7.75 (t, 1H), 7.85 (d, $J = 7.2$ Hz, 1.96H), 8.01 (d, $J = 7.5$ Hz, 0.9H), 8.14 (d, $J = 7.4$ Hz, 0.86H), 8.47 (m, 1.12H).

^{13}C NMR (75 MHz): δ 165.8, 164.9, 162.8, 158.1, 153.8, 148.3, 145.3, 142.3, 140.6, 137.6, 136.6, 134.4, 134.1, 130.3, 128.5, 128.2, 127.9, 127.5, 127.4, 127.3, 126.8, 125.6, 124.6, 123.6, 116.1, 114.3, 110.3, 110.1, 66.1, 57.9, 55.5, 53.7, 52.1, 51.8, 39.7, 34.3, 31.9.

HRMS (EI) Calcd. for $\text{C}_{23}\text{H}_{16}\text{N}_4\text{O}_6\text{S}$: 476.0725, Found: 476.0765.

1,1-Dicyano-2phenyl-1,9a-dihydro-2H-9-thia-4a-aza-fluorene-3,4-dicarboxylic acid dimethyl ester (19a & 19b).

Following the general procedure, with benzothiazole **1**, DMAD and phenyl dicyanostyrene, the diastereomeric mixture of the product 1,1-dicyano-2phenyl-1,9a-

dihydro-2*H*-9-thia-4a-aza-fluorene-3,4-dicarboxylic acid dimethyl ester **19a** & **19b** was obtained as a yellow solid in 55% yield.

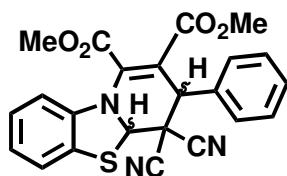

19a & **19b**

IR (KBr) ν_{\max} : 3043, 2219, 1742, 1706, 1681, 1623, 1584, 1439, 1353, 1218, 1173, 1019, 983 cm^{-1} .

^1H NMR [300 MHz, $\text{CDCl}_3/\text{CCl}_4$, 7:3 (v/v)]: δ 3.43 (s, 3H), 3.56 (s, 2.6H), 3.78 (s, 3H), 3.95 (s, 2.47H), 4.49 (s, 1.4H), 5.63 (s, 0.5H), 5.81 (s, 0.46H), 6.81-6.93 (m, 2.8H), 7.10-7.07 (m, 6.44H), 7.18-7.29 (m, 5H), 7.50-7.70 (m, 2.19H), 7.71-7.74 (m, 0.98H).

^{13}C NMR (75 MHz): δ 164.4, 163.3, 145.6, 144.9, 137.8, 137.7, 135.1, 132.5, 129.5, 129.2, 128.8, 128.6, 128.3, 127.3, 127.7, 127.1, 126.8, 126, 125.4, 125.1, 123.7, 122.2, 116.4, 113.4, 112.2, 110.3, 106.1, 96.4, 53.4, 53.1, 52.7, 52.4, 52.1, 29.9, 22.0.

HRMS (EI) Calcd. for $\text{C}_{23}\text{H}_{17}\text{N}_3\text{O}_4\text{S}$: 431.0949. Found: 431.0934.

2-(4-Chlorophenyl)-1,1-dicyano-1,9a-dihydro-2*H*-9-thia-4a-aza-fluorene-3,4-dicarboxylic acid dimethyl ester (20a** & **20b**).**

Following the general procedure, with benzothiazole **1**, DMAD and 4-chlorophenyldicyanostyrene, the diastereomeric mixture of the product 2-(4-chlorophenyl)-1,1-dicyano-1,9a-dihydro-2*H*-9-thia-4a-aza-fluorene-3,4-dicarboxylic acid dimethyl ester **20a** & **20b** was obtained as a yellow solid in 75% yield.

IR (KBr) ν_{\max} : 3017, 2221, 1738, 1703, 1631, 1601, 1583, 1570, 1317, 1267, 1207, 1165, 1061, 1013, 759 cm^{-1} .

^1H NMR [300 MHz, $\text{CDCl}_3/\text{CCl}_4$, 7:3 (v/v)]: δ 3.58 (s,

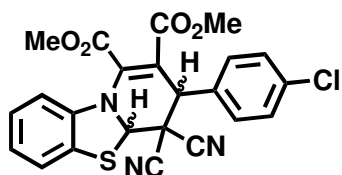

20a & 20b

3H), 3.68 (s, 1.6H), 3.80 (s, 3H), 3.87 (s, 1.8H), 4.42 (s, 1.81H), 5.69 (s, 0.8H), 5.78 (s, 0.5H), 6.95 (m, 1.7H), 6.97-7.05 (m, 3H), 7.11-7.36 (m, 4H), 7.38-7.54 (m, 3H), 7.71 (d, $J = 8.1$ Hz, 2.4H).

^{13}C NMR (75 MHz): δ 164.2, 162.9, 145.9, 145.1, 137.6, 136.5, 134.1, 130.2, 129.8, 129.4, 129.3, 129.1, 128.6, 127.8, 126.8, 125.3, 124.9, 123.2, 122.6, 116.3, 110.2, 110.7, 96.2, 58.2, 52.3, 52, 51.9, 47.1, 30.1.

HRMS (EI) Calcd. for $\text{C}_{23}\text{H}_{16}\text{ClN}_3\text{O}_4\text{S}$: 465.0550, Found: 465.0558.

1,1-Dicyano-2-(4-fluorophenyl)-1,9a-dihydro-2H-9-thia-4a-aza-fluorene-3,4-dicarboxylic acid dimethyl ester (21a & 21b).

Following the general procedure, with benzothiazole **1**, DMAD and 4-fluorophenyldicyanostyrene, the diastereomeric mixture of the product 1,1-dicyano-2-(4-fluorophenyl)-1,9a-dihydro-2H-9-thia-4a-aza-fluorene-3,4-dicarboxylic acid dimethyl ester **21a & 21b** was obtained as a yellow solid in 69% yield.

IR (KBr) ν_{max} : 2987, 2212, 1745, 1714, 1593, 1557, 1533, 1487, 1429, 1379, 1110 cm^{-1} .

^1H NMR [300 MHz, $\text{CDCl}_3/\text{CCl}_4$, 7:3 (v/v)]: δ 3.45 (s, 3H), 3.52 (s, 1.43H), 3.75 (s, 3H), 3.81 (s, 1.36H), 4.61 (s, 1.9H), 5.56 (s, 0.91H), 5.83 (s, 0.99H), 6.89-6.91 (m, 2.4H), 6.92-7.04 (m, 5H), 7.31-7.34 (m, 4.3H), 7.56-7.69 (m, 4H), 7.74 (d, $J = 7.6$ Hz, 2.3H).

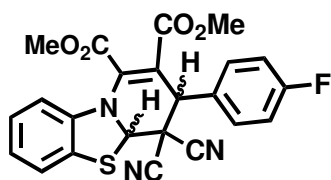

21a & 21b

^{13}C NMR (75 MHz): δ 164.2, 162.9, 145.9, 145.1, 137.6, 136.5, 134.1, 130.7, 129.8, 129.4, 129.3, 129.1, 128.6, 127.8, 127.5, 127.4, 126.8, 125.3, 124.9, 123.6, 123.2, 122.3, 116.3, 110.2, 110.7, 96.2, 58.2, 53.2, 52.9,

52.3, 52, 51.9, 47.1, 30.1.

HRMS (EI) Calcd for $C_{23}H_{16}FN_3O_4S$: 449.0846und:
449.0867.

1,1-Dicyano-2-(4-methoxyphenyl)-1,9a-dihydro-2H-9-thia-4a-aza-fluorene-3,4-dicarboxylic acid dimethyl ester (22a & 22b).

Following the general procedure, with benzothiazole **1**, DMAD and 4-methoxyphenyldicyanostyrene, the diastereomeric mixture of the product 1,1-dicyano-2-(4-methoxyphenyl)-1,9a-dihydro-2H-9-thia-4a-aza-fluorene-3,4-dicarboxylic acid dimethyl ester **22a & 22b** was obtained as a yellow solid in 41% yield.

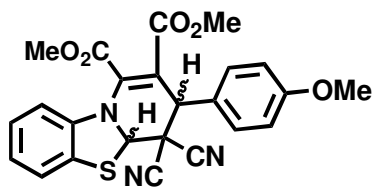

22a & 22b

IR (KBr): ν_{\max} : 3001, 2951, 1744, 1708, 1609, 1579, 1510, 1458, 1437, 1373, 1346, 1252, 1233, 1202, 1169, 1115, 1090, 1032, 988, 935, 912, 788 cm^{-1} .

1H NMR [300 MHz, $CDCl_3/CCl_4$, 7:3 (v/v)]: δ 3.58 (s, 3H), 3.68 (s, 1.6H), 3.80 (s, 3H), 3.87 (s, 1.8H), 4.42 (s, 1.81H), 5.69 (s, 0.8H), 5.78 (s, 0.5H), 6.95 (m, 1.7H), 6.97-7.05 (m, 3H), 7.11-7.36 (m, 4H), 7.38-7.54 (m, 3H), 7.71 (d, $J = 8.1$ Hz, 2.4H).

^{13}C NMR (75 MHz): δ 165.1, 164.5, 163.4, 163.1, 159.6, 159.5, 153.8, 145.6, 137.7, 137.1, 136.4, 135.1, 132.8, 132.2, 129.9, 129.7, 129.6, 129.4, 129.3, 129.2, 127.6, 127.5, 126.6, 107, 58, 53.1, 52.9, 52.2, 51.9, 47.1, 30.1.

HRMS (EI): Calcd for $C_{24}H_{19}N_3O_5S$: 461.1045.
Found: 461.1057.

3.8 References

1. Abbott, P. J.; Acheson, R. M.; Eisner, U.; Watkin, D. J.; Carruthers, J. R. *J. Chem. Soc., Chem. Commun.* **1975**, 155.
2. Ogura, H.; Kikuchi, K.; Takayanagi, H.; Furuhashi, K.; Iitaka, I.; Acheson, R. M. *J. Chem. Soc., Perkin Trans. I* **1975**, 2316.
3. Pillai, A. N.; Devi, B. R.; Suresh, E.; Nair, V. *Tetrahedron Lett.* **2007**, 48, 4391.

4.1.1 Addition of Phosphine

Tebby and coworkers have studied the reactivity of triphenylphosphine towards dimethyl acetylenedicarboxylate (DMAD) in detail. The initial event is the formation of the dipole and the reaction proceeds through different routes depending on the stoichiometry of the reagents used. In presence of excess triphenylphosphine, the phosphorane is obtained while in the presence of excess DMAD, the dimerized product of carbene was formed.² Winterfeldt has made the interesting observation that the 1:1 intermediate derived from triphenylphosphine and DMAD can be trapped with benzaldehyde. The reaction furnished unsaturated lactone and benzoyl fumarate in very low yields.³ Later Nozaki has applied this reaction to activated carbonyl compounds such as α -ketoesters and α -ketonitriles as dipolarophiles. The use of catalytic amount of triphenylphosphine afforded unsaturated lactones in moderate to high yields.⁴

Work in our laboratory has shown that the zwitterionic intermediate, generated from PPh_3 and DMAD, undergoes a facile addition to 1,4-benzoquinone **4** to afford highly functionalized unsaturated γ -spirolactones **6** and **7** in good yields (Scheme 4.2).⁵ The reaction occurs with 1,2-benzoquinones also.

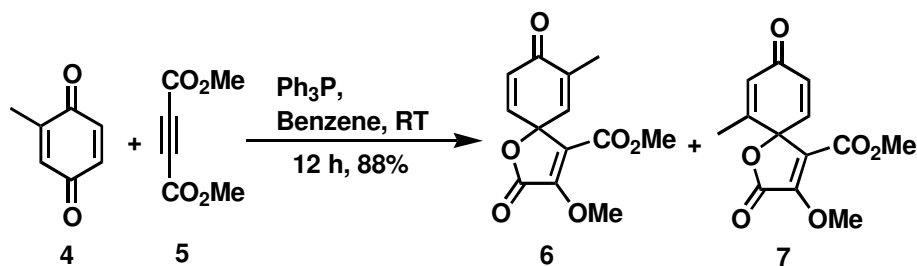

Scheme 4.2

4.1.2 Addition of Isocyanides

Winterfeldt and coworkers have investigated the addition of isocyanides to DMAD in detail. The initially formed 1:1 dipolar intermediate undergoes further reaction with DMAD and isocyanide in different molar proportions, leading to a variety of complex heterocyclic systems.⁶

Experiments conducted in our laboratory have shown that aldehydes are suitable reaction partners in trapping the 1,3-dipole generated from cyclohexyl isocyanide **8** and DMAD and thus constituting a novel synthesis of aminofuran derivatives **10** (Scheme 4.3).⁷

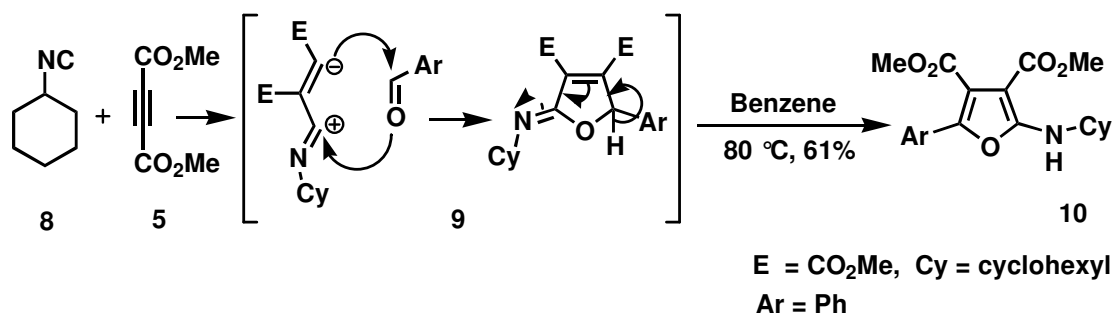

Scheme 4.3

When *N*-tosylimines were used as the third component, the reaction afforded good yields of aminopyrroles (Scheme 4.4).⁸ Various carbonyl dipolarophiles like quinones and quinoneimines,⁹ 1,2-diones¹⁰ were also reactive towards the dipole affording novel heterocyclic systems.

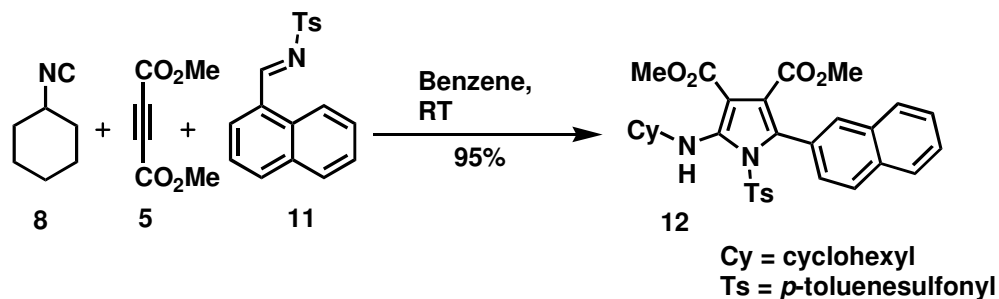

Scheme 4.4

4.1.3 Addition of Nucleophilic Carbenes

Nucleophilic carbenes are characterized by the presence of substituents carrying donor atoms such as oxygen, nitrogen, phosphorous and sulfur. The heteroatoms stabilize the singlet ground state of the carbene by conjugative donation of electrons into the vacant p-orbital of the carbene center (Figure 4.1).¹¹

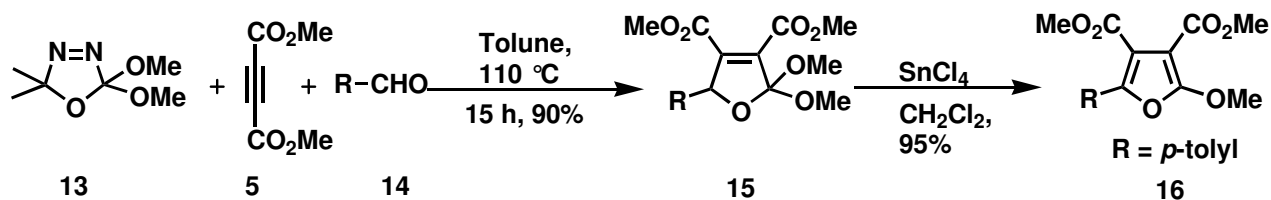

Figure 4.1

4.1.3a Dimethoxycarbene

Attempts to trap dimethoxycarbene, formed *in situ*, with DMAD, surprisingly, led to the formation of dihydrofuran derivative instead of cyclopropane in low yield, presumably by the addition of the initially formed zwitterion to another molecule of DMAD.^{12,13} The synthetic potential of the dipole generated by the addition of dimethoxycarbene to DMAD was realized by its interception with a variety of dipolarophiles like aldehydes, enones, dienones, quinones, dicyanostyrenes *etc* thus

constituting novel multicomponent reactions (MCRs).¹⁴ A representative example of this class of reactions is given below (Scheme 4.5).



Scheme 4.5

4.1.3b N-Heterocyclic Carbenes (NHCs)

Ever since the isolation of a stable crystalline diaminocarbene by Arduengo in 1991, there has been growing interest in the area of N-heterocyclic carbenes (NHCs).¹⁵ The first multicomponent reaction using NHC was developed by our group wherein, the dipolar intermediate generated by the addition of NHC to DMAD was intercepted with aldehyde **18** (Scheme 4.6).¹⁶

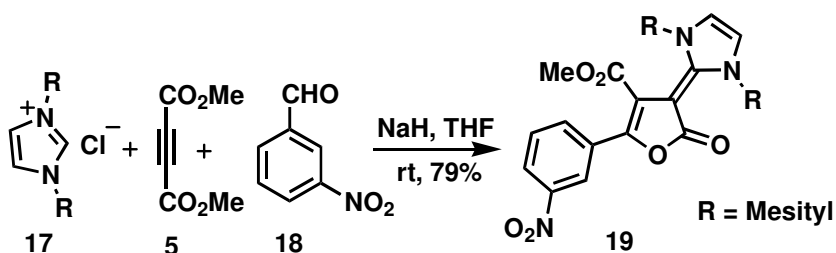

Scheme 4.6

4.1.4 Addition of Pyridine and Related Species

In 1932 Diels and Alder reported that pyridine reacts with DMAD to give a 1:2 adduct,¹⁷ which was shown to be 4*H*-quinolizine by Acheson and coworkers (see also chapter 1).¹⁸ The formation of **22** was explained by invoking a stepwise addition of

pyridine to DMAD resulting in a 1,4-dipole **21** and the reaction of the latter with a second molecule of DMAD (Scheme 4.7).

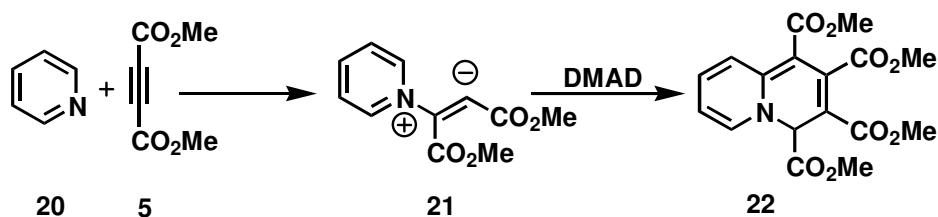

Scheme 4.7

The formation of the 1,4-dipole was established by trapping with CO_2 , (Scheme 4.8).¹⁹

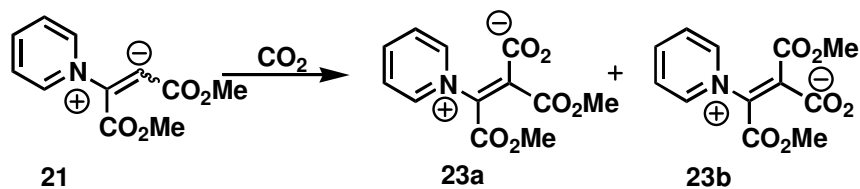

Scheme 4.8

Acheson *et al.* have reported that the reaction of pyridine with DMAD in methanol afforded the products **27** and **28** presumably by the protonation of 1,4-dipole **21**, followed by the addition of methoxide ion and reaction of the newly generated zwitterion with a second molecule of DMAD (Scheme 4.9).²⁰

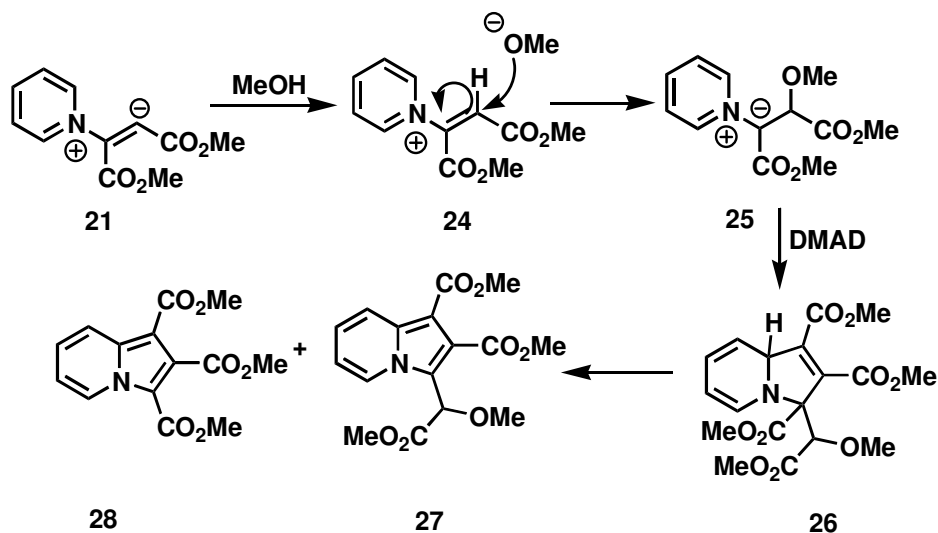

Scheme 4.9

Winterfeldt *et al.* have reported that the intramolecular cyclization induced by 1,4-dipole to a carbonyl group gives 2*H*-quinolizone **30** as the major product in polar solvents whereas 4*H*-quinolizone **31** predominates in non-polar solvents (Scheme 4.10).²¹

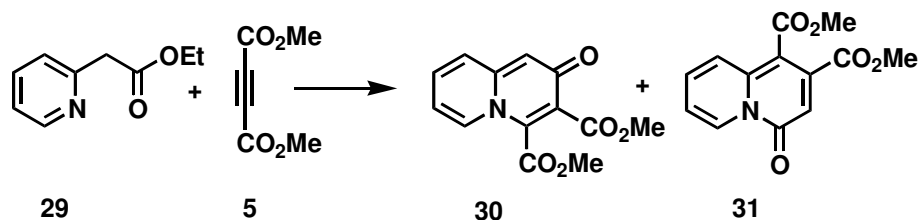

Scheme 4.10

Intramolecular cyclization on an olefinic bond resulted in the direct synthesis of 2*H*-quinolizines (Scheme 4.11).²²

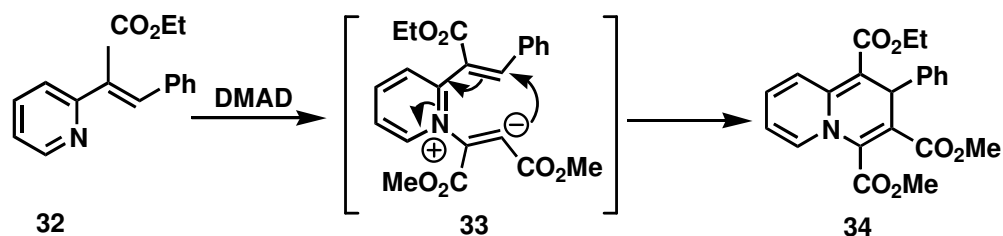

Scheme 4.11

Interestingly, the reaction of pyridine and DMAD with excess of phenylisocyanate afforded pyrimidindione **37** *albeit* only in 25% yield (see chapter 1, section 1.6). The reaction proceeds through an initial 1,5-dipole **35** which adds to another molecule of phenylisocyanate to form a 1,7-dipole **36** and the latter subsequently undergoes a ring closure to form pyrimidindione **37** with the elimination of pyridine (Scheme 4.12).²³

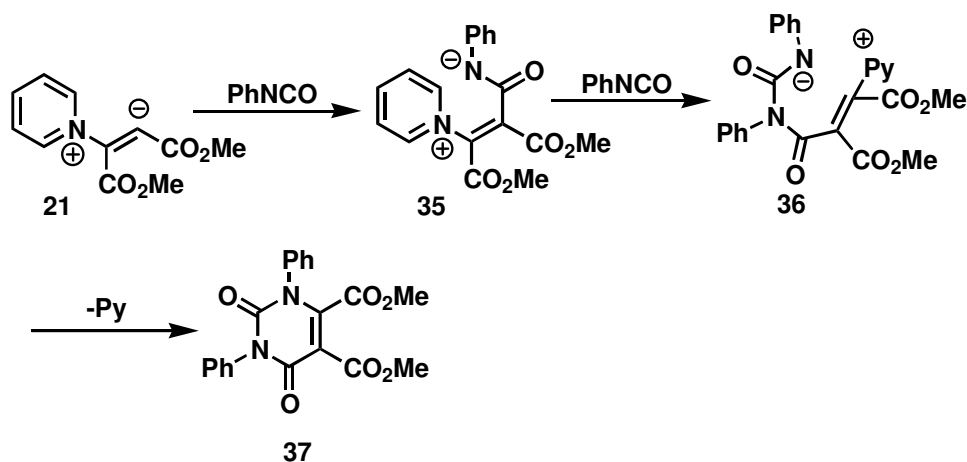

Scheme 4.12

Recent work in our laboratory has shown that 1,4-dipole generated from pyridine and DMAD undergoes addition to aldehyde **18** and *N*-tosylimine **39** to give

the corresponding benzoylfumarate **38** and 1-azadiene **40** derivatives in good yields (Scheme 4.13).²⁴

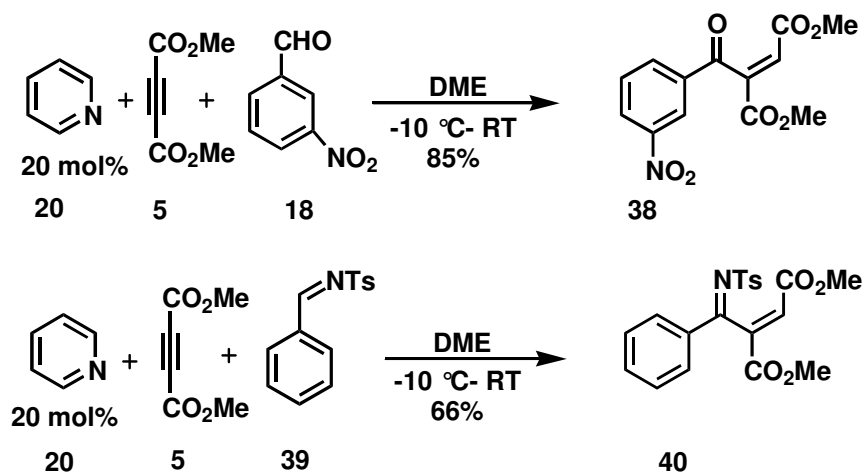

Scheme 4.13

Subsequent work has shown that pyridine catalyzed reaction of DMAD with benzil afforded the dibenzoyl maleate **42** in good yield (Scheme 4.14).²⁵

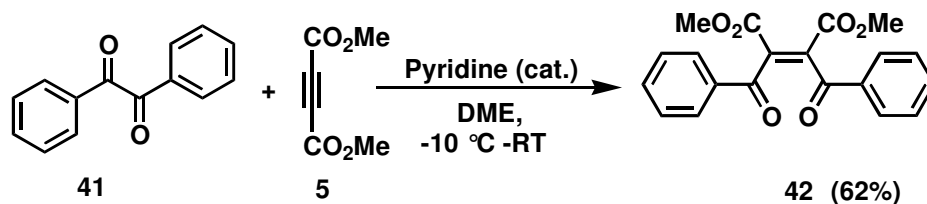

Scheme 4.14

4.2 Statement of the Problem

The literature survey clearly indicates that the interception of pyridine-DMAD zwitterion with carbon-heteroatom multiple bonds have been so far reported. But there were no attempts to intercept this zwitterion with carbon-carbon double bonds. Due to our long standing interest in the chemistry of zwitterions, we were intrigued by the

possibility of intercepting the pyridine-DMAD zwitterion with carbon-carbon double bonds (activated alkenes). β -dicyanostyrenes was the choice of dipolarophile as the carbon-carbon multiple bond is activated by the presence of two cyano groups. If the reaction takes place in the same manner as reported in other cases, this will lead to the synthesis of highly substituted butadiene derivatives. The results validating our assumption are reported in the following section.

4.3 Results and Discussion

The dicyanostyrenes were prepared by the condensation of aromatic aldehydes with malononitriles in presence of ammonium acetate and a drop of acetic acid at 60 °C in benzene for 6 h (see also chapter 2, section 2.3).

4.3.1 Reactions of Pyridine and DMAD with Activated Styrenes

Our investigations began with an experiment in which benzylidenemalononitrile **43**, was treated with dimethyl acetylenedicarboxylate (DMAD) in presence of catalytic amount of pyridine (20 mol%) in dry dimethoxy ethane (DME) at -10 °C followed by warming to room temperature for 3.5 h under an argon atmosphere. The solvent was then removed under vacuum and the residue on chromatographic separation on silica gel using hexane-ethyl acetate (95:5) gave the highly substituted butadiene derivative, dimethyl (2E)-2-(2,2-dicyano-1-phenylvinyl)but-2-enedioate **44** as a pale yellow liquid (61%) (Scheme 4.15).

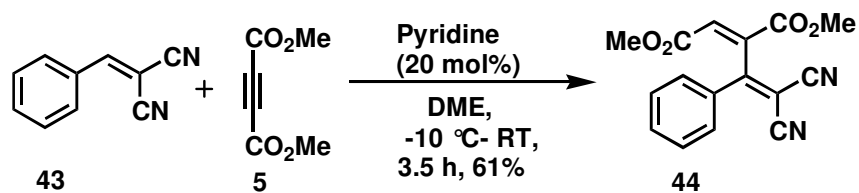

Scheme 4.15

Characterization of the product was based on spectroscopic data. In the IR spectrum, the peak at 2231 cm^{-1} was assigned to the cyano group and a sharp signal at 1729 cm^{-1} was attributed to the ester carbonyl group. In the ^1H NMR spectrum, the carbomethoxy protons resonated as singlets at δ 3.84 and 3.78. The olefinic proton was discernible as a singlet at δ 7.20. In the ^{13}C NMR spectrum, the characteristic signal due to the carbomethoxy carbonyls were seen at δ 168.4 and 163.3, the corresponding methyl carbons were discernible at δ 53.7 and 52.7, while the signal of the two cyano carbons were observed at δ 112.3 and 111.6. All other signals were in accordance with the structure assigned. The compound also afforded satisfactory HRMS data.

To explore the generality and scope of this process, similar substrates were subjected to the reaction under identical conditions. Thus dicyanostyrenes with electron withdrawing or donating groups on the phenyl ring were found to participate in the reaction, yielding the corresponding 1,3-butadienes in good to excellent yields. The results are summarized in Table 4.1.

Table 4.1. Reaction of substituted arylidenemalononitriles and DMAD catalyzed by pyridine.

Entry	Styrene	Product	Yield (%)
1			59
2			67
3			88
4			71
5			78
6			87
7			82
8			92

Table 4.1 (Continued)

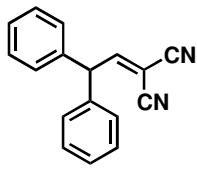
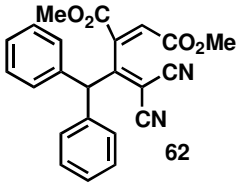
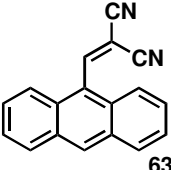
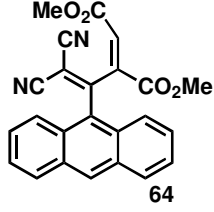
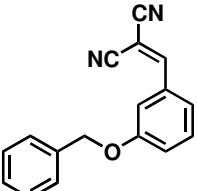
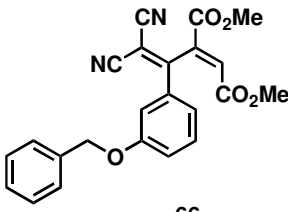
Entry	Styrene	Product	Yield (%)
9	 61	 62	43
10	 63	 64	30
11	 65	 66	75

In all cases, the products were completely characterized and their structures were established by spectroscopic methods.

Interestingly, introduction of extended conjugation in the olefinic component did not alter the reaction path; the expected product, dimethyl(2E)-2-[(2E)-1-(dicyanomethylene)-3-phenylprop-2-enyl]but-2-enedioate **68** was obtained from the diene (Scheme 4.16).

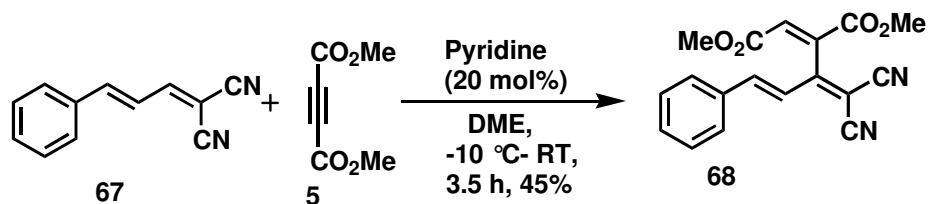

Scheme 4.16

The structure of the product was elucidated by spectroscopic techniques. In the IR spectrum, absorption at 2225 cm^{-1} can be attributed to the cyano group and a sharp band at 1724 cm^{-1} was assigned to the ester carbonyl group. In the ^1H NMR spectrum, the carbomethoxy groups resonated as singlets at δ 3.89 and 3.79 and the olefinic proton signal was observed as a singlet at δ 6.93. In the ^{13}C NMR spectrum the carbomethoxy carbonyls resonated at δ 164.9 and 163.0; the corresponding methyl carbons were discernible at δ 53.9 and 52.8. The two cyano carbons were observed at δ 112.3 and 111.6. The compound also afforded satisfactory elemental analysis. To establish the stereochemistry of the trisubstituted double bond, we resorted to single crystal X-ray analysis (Figure 4.4). It was evident from the X-ray structure that the carbomethoxy groups are *trans* to each other.

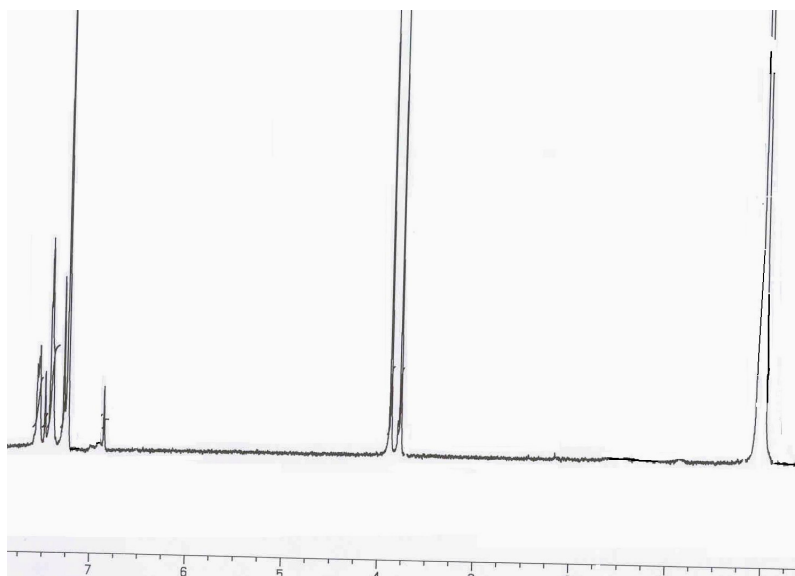

Figure 4. 2: ^1H NMR spectrum of 68.

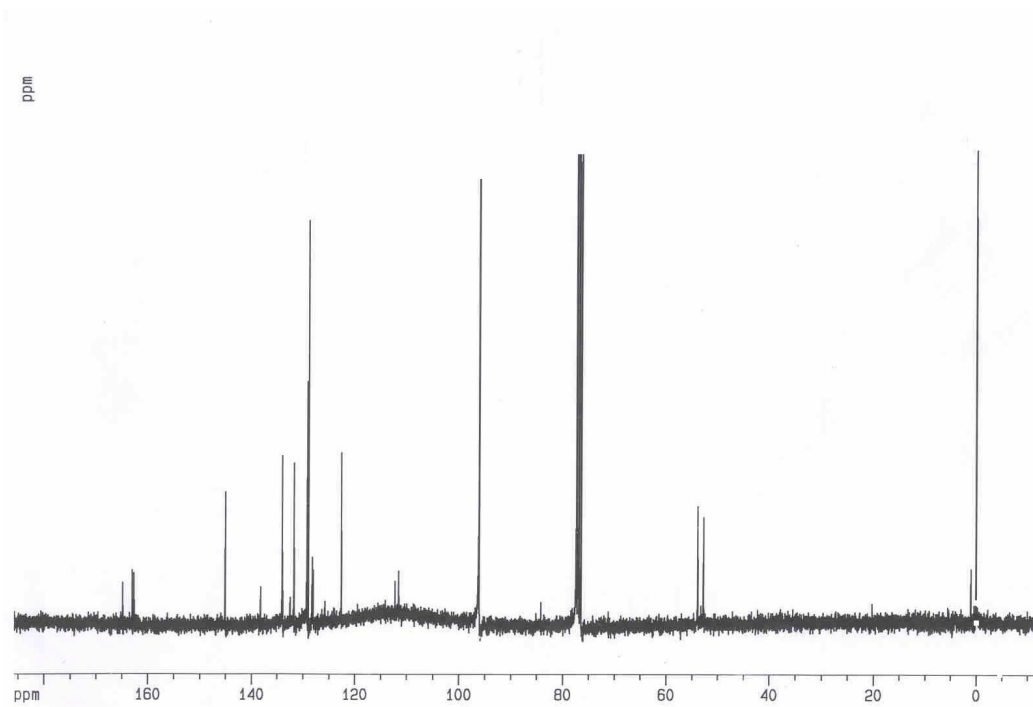

Figure 4.3: ^{13}C NMR spectrum of 68

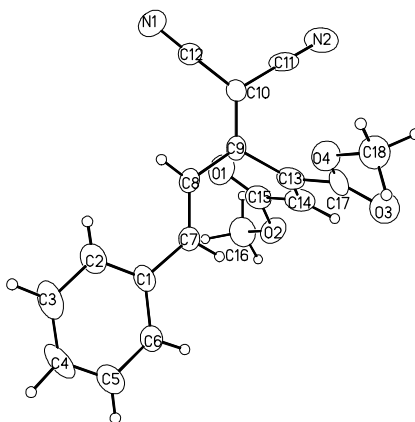
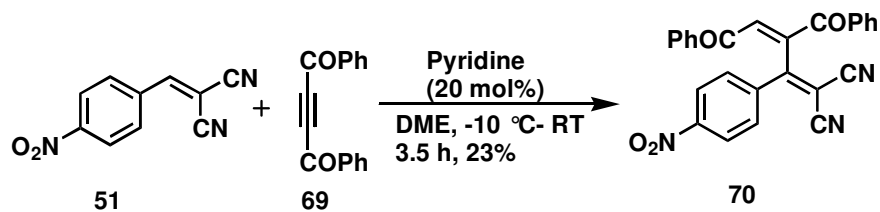

Figure 4.4: Single crystal X-ray structure of 68.

Activated acetylenes like dibenzoyl acetylene (DBA) **69** was also found to participate in this type of reaction under similar reaction conditions affording the [2(E)-2-benzoyl-1-(4-nitrophenyl)-4-oxo-4-phenylbut-2-enylidene]malononitrile **70** *albeit* in low yield (Scheme 4.17).



Scheme 4.17

The product was purified by column chromatography and its structure was assigned on the basis of spectroscopic data. In the IR spectrum, peak at 2232 cm^{-1} corresponds to cyano group and the absorptions at 1670 and 1665 cm^{-1} were attributed to the two carbonyl groups. In the ^1H NMR spectrum, the olefinic proton signal was

observed as a singlet at δ 6.89. In the ^{13}C NMR spectrum, the two carbonyl groups were seen at δ 176.3 and 173.5 respectively.

4.3.2 Mechanistic Considerations

A mechanistic postulate for this reaction may be given as follows. The initial step involves the formation of a 1:1 dipolar intermediate between pyridine and DMAD and this 1,4-dipole adds to the electrophilic carbon-carbon double bond of dicyanostyrene **43**, yielding the intermediate **71**. Subsequently, it undergoes isomerization and σ -bond rotation followed by the elimination of pyridine, resulting in the formation of 1,3-butadiene derivative with *E*-configuration, as depicted in Scheme 4.18. It may be surmised that the stereo selectivity of the reaction is predicated on the elimination of pyridine occurring from the rotamer, which is stereoelectronically disposed for the favorable *trans* elimination.

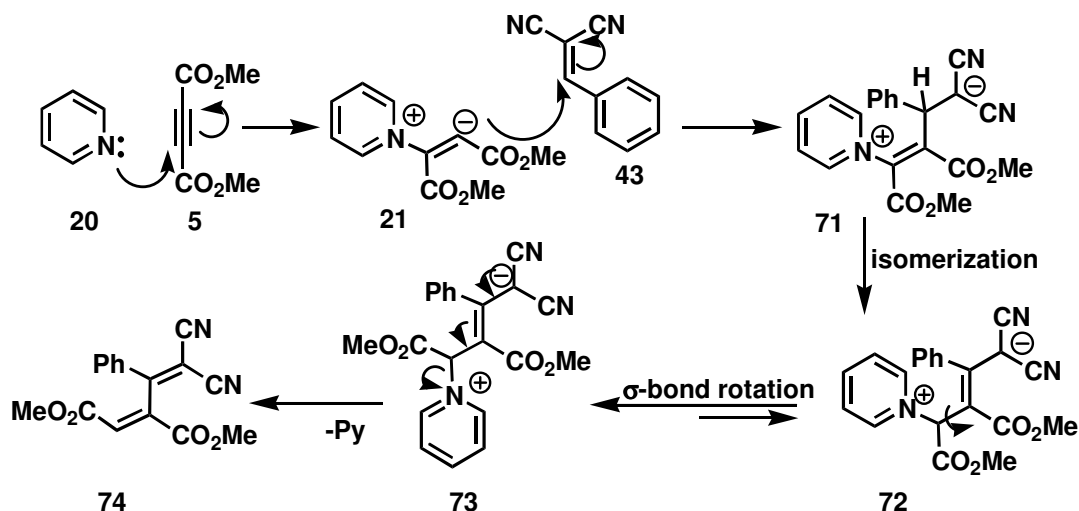

Scheme 4.18

4.4 Conclusion

In conclusion, we have uncovered a novel reaction where dicyanostyrenes add to activated acetylenes under mild conditions. Pyridine acts as a mediator for carbon-

carbon bond formation during the reaction. This reaction offers a simple and efficient route to the novel synthesis of highly substituted 1,3-butadienes.

4.5 Experimental Details

General

General information about the experiments is given in section 2. 5.

Dimethyl-(2E)-2-(2,2-dicyano-1-phenylvinyl)but-2-enedioate (44).

A solution of DMAD (170 mg, 1.2 mmol) and **43** (154 mg, 1 mmol) in dry DME (10 mL) under an argon atmosphere was cooled to -10 °C. To this pyridine (16 mg, 0.2 mmol) was added and the reaction mixture was stirred for 3.5 h at room temperature. The solvent was then removed under vacuum and the residue on chromatographic separation on silica gel column using hexane-ethyl acetate mixture (95:5) gave the product, dimethyl-(2E)-2-(2,2-dicyano-1-phenylvinyl)but-2-enedioate **44** as a pale yellow liquid (61%).

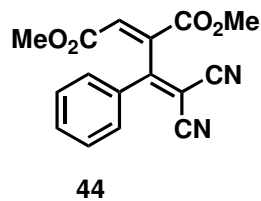

IR (Neat) ν_{\max} : 2955, 2924, 2231, 1729, 1641, 1439, 1362, 1263, 1217, 1093, 1015, 798, 762 cm^{-1} .

^1H NMR [300 MHz, $\text{CDCl}_3/\text{CCl}_4$, 7:3 (v/v)]: δ 7.68 (d, $J = 7.5$ Hz, 2H), 7.58-7.25 (m, 3H), 7.20 (s, 1H), 3.84 (s, 3H), 3.78 (s, 3H).

^{13}C NMR (75 MHz): δ 168.4, 163.3, 143.2, 135.6, 133.8, 132.8, 132.7, 132.6, 129.6, 129.0, 128.7, 112.3, 111.6, 103.7, 53.7, 52.7.

HRMS (EI) Calcd. for $\text{C}_{16}\text{H}_{12}\text{N}_2\text{O}_4$: 296.0797. Found: 296.0567.

Dimethyl-(2E)-2-[2,2-dicyano-1-(4-methylphenyl)vinyl]but-2-enedioate (46).

A solution of DMAD (170 mg, 1.2 mmol) and **45** (168 mg, 1 mmol) in dry DME (10 mL) under an argon atmosphere was cooled to -10 °C. To this pyridine

(16mg, 0.2 mmol) was added and the reaction mixture was stirred for 3.5 h at room temperature. The solvent was then removed under vacuum and the residue on chromatographic separation on silica gel column using hexane-ethyl acetate mixture (95:5) gave the product, dimethyl-(2E)-2-[2,2-dicyano-1-(4-methylphenyl)vinyl]but-2-enedioate **46** as a pale yellow liquid (59%).

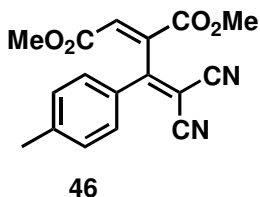

IR (Neat) ν_{\max} : 2931, 2222, 2220, 1738, 1659, 1609, 1521, 1429, 1322, 1126 cm^{-1} .

^1H NMR [300 MHz, $\text{CDCl}_3/\text{CCl}_4$, 7:3 (v/v)]: δ 7.61 (d, J = 7.8 Hz, 2H), 7.40-7.21 (m, 2H), 7.01 (s, 1H), 3.79 (s, 3H), 3.66 (s, 3H), 2.44 (s, 3H).

^{13}C NMR (75 MHz): δ 165.8, 163.7, 145.0, 144.8, 144.7, 144.6, 133.1, 131.2, 130.0, 129.4, 128.8, 112.2, 112.1, 104.7, 53.0, 52.5, 21.3.

HRMS (EI) Calcd for $\text{C}_{17}\text{H}_{14}\text{N}_2\text{O}_4$: 310.3041. Found: 310.2911.

Dimethyl-(2E)-2-[1-(3-chlorophenyl)-2,2-dicyanovinyl]but-2-enedioate (**48**).

A solution of DMAD (170 mg, 1.2 mmol) and **47** (188 mg, 1mmol) in dry DME (10 mL) under an argon atmosphere was cooled to $-10\text{ }^\circ\text{C}$. To this pyridine (16 mg, 0.2 mmol) was added and the reaction mixture was stirred for 3.5 h at room temperature. The solvent was then removed under vacuum and the residue on chromatographic separation on silica gel column using hexane-ethyl acetate mixture (95:5) gave the product, dimethyl-(2E)-2-[1-(3-chlorophenyl)-2,2-dicyanovinyl]but-2-enedioate **48** as a pale yellow liquid (67%).

IR (Neat) ν_{\max} : 3031, 2928, 2231, 2229, 1735, 1659, 1548, 1540, 1429, 1412, 1277, 1118 cm^{-1} .

^1H NMR [300 MHz, $\text{CDCl}_3/\text{CCl}_4$, 7:3 (v/v)]: δ 7.73 (s, 1H), 7.61 (d, J = 7.1 Hz, 1H), 7.52-7.44 (m, 2H), 7.07 (s, 1H),

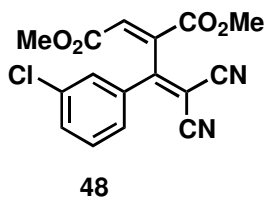

3.68 (s, 3H), 3.61 (s, 3H).

^{13}C NMR (75 MHz): δ 164.1, 163.5, 145.2, 144.5, 137.7, 137.4, 137.0, 135.2, 134.1, 133.8, 130.6, 128.4, 112.2, 112.0, 53.2, 52.8.

HRMS (EI) Calcd. for $\text{C}_{16}\text{H}_{11}\text{ClN}_2\text{O}_4$: 330.0407. Found: 330.0392.

Dimethyl-(2E)-2-[2,2-dicyano-1-(4-trifluoromethylphenyl)vinyl]but-2-enedioate (50).

A solution of DMAD (170 mg, 1.2 mmol) and **49** (222 mg, 1mmol) in dry DME (10 mL) under an argon atmosphere was cooled to $-10\text{ }^\circ\text{C}$. To this pyridine (16 mg, 0.2 mmol) was added and the reaction mixture was stirred for 3.5 h at room temperature. The solvent was then removed under vacuum and the residue on chromatographic separation on silica gel column using hexane-ethyl acetate mixture (95:5) gave the product, dimethyl-(2E)-2-[2,2-dicyano-1-(4-trifluoromethylphenyl)vinyl]but-2-enedioate **50** as a pale yellow liquid (88%).

IR (Neat) ν_{max} : 2931, 2927, 2228, 2221, 1733, 1688, 1521, 1501, 1473, 1428, 1321, 1277 cm^{-1} .

^1H NMR [300 MHz, $\text{CDCl}_3/\text{CCl}_4$, 7:3 (v/v)]: δ 7.82 (d, $J = 7.8\text{ Hz}$, 2H), 7.67 (d, $J = 7.7\text{ Hz}$, 2H), 7.10 (s, 1H), 3.71 (s, 3H), 3.62 (s, 3H).

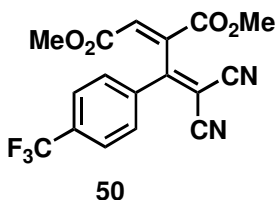

^{13}C NMR (75 MHz): δ 165.2, 164.2, 147.1, 145.7, 138.22, 134.6, 130.2, 128.1, 126.8, 125.5, 125.2, 121.6, 113.2, 112.1, 111.8, 53.5, 52.8.

HRMS (EI) Calcd. for $\text{C}_{17}\text{H}_{11}\text{F}_3\text{N}_2\text{O}_4$: 364.0671. Found: 364.0620.

Dimethyl-(2E)-2-[2,2-dicyano-1-(4-nitrophenyl)vinyl]but-2-enedioate (52).

A solution of DMAD (170 mg, 1.2 mmol) and **51** (199 mg, 1 mmol) in dry DME (10 mL) under an argon atmosphere was cooled to -10 °C. To this pyridine (16 mg, 0.2 mmol) was added and the reaction mixture was stirred for 3.5 h at room temperature. The solvent was then removed under vacuum and the residue on chromatographic separation on silica gel column using hexane-ethyl acetate mixture (95:5) gave the product, dimethyl-(2E)-2-[2,2-dicyano-1-(4-nitrophenyl)vinyl]but-2-enedioate **52** as a pale yellow liquid (71%).

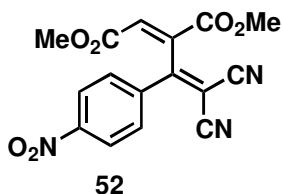

IR (Neat) ν_{\max} : 2957, 2952, 2235, 1738, 1652, 1601, 1528, 1433, 1343, 1302, 1279, 1129 cm^{-1} .

^1H NMR [300 MHz, $\text{CDCl}_3/\text{CCl}_4$, 7:3 (v/v)]: δ 8.21 (d, $J = 8.1$ Hz, 2H), 8.00 (d, $J = 8.0$ Hz, 2H), 7.09 (s, 1H), 3.77 (s, 3H), 3.64 (s, 3H).

^{13}C NMR (75 MHz): δ 164.5, 163.2, 151.7, 146.3, 140.7, 139.1, 135.3, 129.5, 126.2, 123.7, 119.8, 112.5, 112.0, 104.8, 53.5, 52.78.

HRMS (EI) Calcd. for $\text{C}_{16}\text{H}_{11}\text{N}_3\text{O}_6$: 341.0648. Found: 340.9995.

Dimethyl-(2E)-2-[2,2-dicyano-1-(4-methoxyphenyl)vinyl]but-2-enedioate (54)

A solution of DMAD (170 mg, 1.2 mmol) and **53** (184 mg, 1 mmol) in dry DME (10 mL) under an argon atmosphere was cooled to -10 °C. To this pyridine (16 mg, 0.2 mmol) was added and the reaction mixture was stirred for 3.5 h at room temperature. The solvent was then removed under vacuum and the residue on chromatographic separation on silica gel column using hexane-ethyl acetate mixture (95:5) gave the product, dimethyl-(2E)-2-[2,2-dicyano-1-(4-methoxyphenyl)vinyl]but-2-enedioate **54** as a pale yellow liquid (78%).

IR (Neat) ν_{\max} : 3030, 2960, 2851, 2231, 1729, 1589,

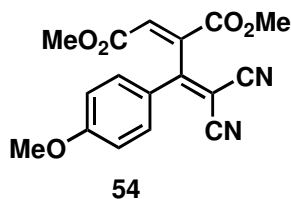

1548, 1486, 1362, 1263, 1186, 1020 cm^{-1} .

$^1\text{H NMR}$ [300 MHz, $\text{CDCl}_3/\text{CCl}_4$, 7:3 (v/v)]: δ 7.64 (d, $J = 8.9$ Hz, 2H), 7.38 (s, 1H), 6.97 (s, 1H), 6.95 (s, 1H), 3.90 (s, 3H), 3.76 (s, 3H).

$^{13}\text{C NMR}$ (75 MHz): δ 167.0, 163.2, 141.1, 132.8, 131.1, 126.6, 124.8, 120.0, 115.3, 114.6, 114.1, 112.9, 112.7, 55.5, 53.7, 52.7, 30.8.

HRMS (EI) Calcd. for $\text{C}_{17}\text{H}_{14}\text{N}_2\text{O}_5$: 326.0903. Found: 325.9958.

Dimethyl-(2E)-2-[1-(4-chlorophenyl)-2,2-dicyanovinyl]but-2-enedioate (**56**).

A solution of DMAD (170 mg, 1.2 mmol) and **55** (188 mg, 1 mmol) in dry DME (10 mL) under an argon atmosphere was cooled to -10 °C. To this pyridine (16 mg, 0.2 mmol) was added and the reaction mixture was stirred for 3.5 h at room temperature. The solvent was then removed under vacuum and the residue on chromatographic separation on silica gel column using hexane-ethyl acetate mixture (95:5) gave the product, dimethyl-(2E)-2-[1-(4-chlorophenyl)-2,2-dicyanovinyl]but-2-enedioate **56** as a pale yellow liquid (87%).

IR (Neat) ν_{max} : 2958, 2939, 2234, 1733, 1608, 1588, 1482, 1403, 1372, 1269, 1212, 1188, 1099 cm^{-1} .

$^1\text{H NMR}$ [300 MHz, $\text{CDCl}_3/\text{CCl}_4$, 7:3 (v/v)]: δ 7.97 (s, 1H), 7.57 (s, 1H), 7.51 (s, 1H), 7.47 (s, 1H), 7.25 (s, 1H), 3.91 (s, 3H), 3.79 (s, 3H).

$^{13}\text{C NMR}$ (75 MHz): δ 167.2, 162.4, 140.5, 139.3, 133.2, 131.0, 130.1, 129.7, 129.4, 111.9, 111.8, 59.2, 53.8, 30.3, 22.7.

HRMS (EI) Calcd. for $\text{C}_{16}\text{H}_{11}\text{ClN}_2\text{O}_4$: 330.0407. Found: 330.0521.

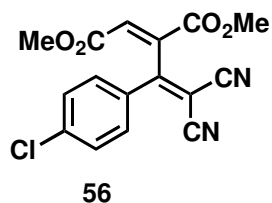

Dimethyl-2-{2,2-dicyano-1-[(5Z,6E)-5,6-diethylidenecyclohexa-1,3-dien-1-yl]vinyl}but-2-ene (60).

A solution of DMAD (170 mg, 1.2 mmol) and **59** (204 mg, 1 mmol) in dry DME (10 mL) under an argon atmosphere was cooled to -10 °C. To this pyridine (16 mg, 0.2 mmol) was added and the reaction mixture was stirred for 3.5 h at room temperature. The solvent was then removed under vacuum and the residue on chromatographic separation on silica gel column using hexane-ethyl acetate mixture (95:5) gave the product, dimethyl-2-{2,2-dicyano-1-[(5Z,6E)-5,6-diethylidenecyclohexa-1,3-dien-1-yl]vinyl}but-2-ene **60** as a pale yellow solid (82%).

IR (KBr) ν_{max} : 2959, 2932, 2219, 1727, 1631, 1602, 1557, 1503, 1483, 1409, 1297, 1222, 1095 cm^{-1} .

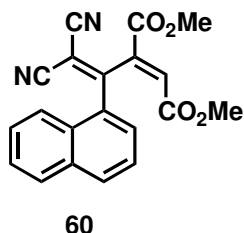

^1H NMR [300 MHz, $\text{CDCl}_3/\text{CCl}_4$, 7:3 (v/v)]: δ 8.06-7.89 (m, 4H), 7.64-7.51 (m, 3H), 7.25 (s, 1H), 3.86 (s, 3H), 3.69 (s, 3H).

^{13}C NMR (75 MHz): δ 164.9, 163.2, 146.5, 135.5, 134.4, 132.2, 131.8, 130.8, 128.8, 128.5, 128.2, 126.7, 125.3, 124.7, 111.8, 111.4, 55.2, 53.4, 52.7, 52.6.

HRMS (EI) Calcd. for $\text{C}_{20}\text{H}_{14}\text{N}_2\text{O}_4$: 346.0954. Found: 346.1255.

Dimethyl-(2E)-2-[2,2-dicyano-1-(4-fluorophenyl)vinyl]but-2-enedioate (58).

A solution of DMAD (170 mg, 1.2 mmol) and **57** (172 mg, 1 mmol) in dry DME (10 mL) under an argon atmosphere was cooled to -10 °C. To this pyridine (16 mg, 0.2 mmol) was added and the reaction mixture was stirred for 3.5 h at room temperature. The solvent was then removed under vacuum and the residue on chromatographic separation on silica gel column using hexane-ethyl acetate mixture

(95:5) gave the product, dimethyl-(2E)-2-[2,2-dicyano-1-(4-fluorophenyl)vinyl]but-2-enedioate **58** as a pale yellow liquid (92%).

IR (Neat) ν_{\max} : 2981, 2955, 2875, 2246, 2210, 1744, 1708, 1667, 1610, 1517, 1439, 1393, 1237, 1150, 1124, 1098, 1056, 1005 cm^{-1} .

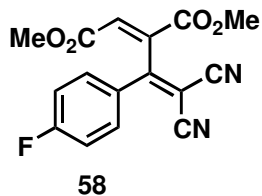

^1H NMR [300 MHz, $\text{CDCl}_3/\text{CCl}_4$, 7:3 (v/v)]: δ 7.56 (d, J = 8.6 Hz, 2H), 7.46 (d, J = 8.7 Hz, 2H), 7.21 (s, 1H), 3.87 (s, 3H), 3.75 (s, 3H).

^{13}C NMR (75 MHz): δ 167.2, 163.3, 140.5, 139.2, 135.1, 134.0, 133.1, 131.7, 130.4, 129.4, 128.5, 111.9, 111.8, 53.8, 52.9, 29.7.

HRMS (EI) Calcd. for $\text{C}_{16}\text{H}_{11}\text{FN}_2\text{O}_4$: 314.0703. Found: 314.0643.

Dimethyl-(2E)-2-(1-benzhydryl-2,2-dicyanovinyl)but-2-enedioate (**62**).

A solution of DMAD (170 mg, 1.2 mmol) and **61** (244 mg, 1 mmol) in dry DME (10 mL) under an argon atmosphere was cooled to $-10\text{ }^\circ\text{C}$. To this pyridine (16 mg, 0.2 mmol) was added and the reaction mixture was stirred for 3.5 h at room temperature. The solvent was then removed under vacuum and the residue on chromatographic separation on silica gel column using hexane-ethyl acetate mixture (95:5) gave the product, dimethyl-(2E)-2-(1-benzhydryl-2,2-dicyanovinyl)but-2-enedioate **62** as a pale yellow liquid (43%).

IR (Neat) ν_{\max} : 2955, 2932, 1728, 1631, 1601, 1588, 1459, 1431, 1344, 1263, 1179, 1093 cm^{-1} .

^1H NMR [300 MHz, $\text{CDCl}_3/\text{CCl}_4$, 7:3 (v/v)]: δ 7.43 (d, J = 8.1 Hz, 2H), 7.29-7.21 (m, 8H), 6.91 (s, 1H), 6.35 (s, 1H), 3.94 (s, 3H), 3.52 (s, 3H).

^{13}C NMR (75 MHz): δ 164.1, 162.3, 155.3, 151.2, 140.7,

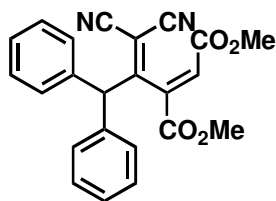

62

139.1, 133.8, 130.1, 128.7, 128.4, 128.3, 128.0, 127.8, 127.0, 125.2, 112.0, 111.9, 111.0, 53.5, 51.6, 29.5.

HRMS (EI) Calcd. for $C_{23}H_{18}N_2O_4$: 386.1267. Found: 386.1186.

Dimethyl-2- $\{2,2$ -dicyano-1-[(2E)-2-ethylidene-3-methylene-2,3-dihydronaphthalen-1-yl]vinyl} (64)

A solution of DMAD (170 mg, 1.2 mmol) and **63** (254 mg, 1 mmol) in dry DME (10 mL) under an argon atmosphere was cooled to $-10\text{ }^\circ\text{C}$. To this pyridine (16 mg, 0.2 mmol) was added and the reaction mixture was stirred for 3.5 h at room temperature. The solvent was then removed under vacuum and the residue on chromatographic separation on silica gel column using hexane-ethyl acetate mixture (95:5) gave the product, dimethyl-2- $\{2,2$ -dicyano-1-[(2E)-2-ethylidene-3-methylene-2,3-dihydronaphthalen-1-yl]vinyl} **64** as a pale yellow liquid (30%).

IR (Neat) ν_{max} : 3058, 2955, 2919, 2236, 1734, 1672, 1589, 1439, 1346, 1279, 1206, 1176 cm^{-1} .

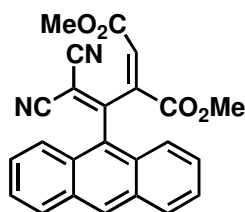

64

^1H NMR [300 MHz, $\text{CDCl}_3/\text{CCl}_4$, 7:3 (v/v)]: δ 8.65 (s, 1H), 8.06 (d, $J = 8.3$ Hz, 2H), 7.74 (d, $J = 8.6$ Hz, 2H), 7.66-7.53 (m, 4H), 7.25 (s, 1H), 5.72 (s, 1H), 4.06 (s, 3H), 3.63 (s, 3H).

^{13}C NMR (75 MHz): δ 164.9, 163.8, 142.4, 134.0, 131.3, 131.0, 129.2, 128.7, 126.1, 125.5, 125.0, 123.4, 111.5, 110.4, 93.3, 53.4, 52.5.

HRMS (EI) Calcd. for $C_{24}H_{16}N_2O_4$: 396.1110. Found: 386.1059.

Dimethyl-(2E)-2-[1-(benzyloxy)-2,2-dicyanovinyl]but-2-enedioate (66)

A solution of DMAD (170 mg, 1.2 mmol) and **65** (260 mg, 1 mmol) in dry DME (10 mL) under an argon atmosphere was cooled to $-10\text{ }^\circ\text{C}$. To this pyridine (16 mg, 0.2 mmol) was added and the reaction mixture was stirred for 3.5 h at room

temperature. The solvent was then removed under vacuum and the residue on chromatographic separation on silica gel column using hexane-ethyl acetate mixture (95:5) gave the product, dimethyl-(2E)-2-[1-(benzyloxy)-2,2-dicyanovinyl]but-2-enedioate **66** as a colorless crystalline solid (75%).

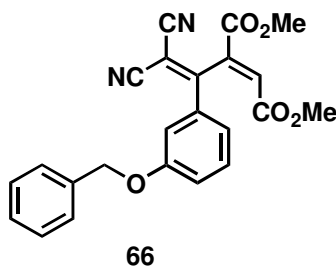

IR (KBr) ν_{\max} : 3089, 3079, 2903, 2113, 1734, 1646, 1605, 1568, 1491, 1439, 1356, 1253, 1165, 1082 cm^{-1} .

$^1\text{H NMR}$: δ 7.42-7.25 (m, 3H), 7.38-7.35 (m, 2H), 7.33-7.30 (m, 2H), 7.18-7.15 (m, 3H), 5.08 (s, 2H), 3.83 (s, 3H), 3.76 (s, 3H).

$^{13}\text{C NMR}$: δ 168.0, 163.3, 158.9, 140.7, 136.1, 135.2, 133.7, 132.9, 130.1, 128.7, 128.2, 127.9, 127.5, 121.4, 119.7, 114.8, 112.2, 112.1, 70.4, 53.7, 52.8.

HRMS (EI) Calcd. for $\text{C}_{23}\text{H}_{18}\text{N}_2\text{O}_5$: 402.1216. Found: 402.1206.

Dimethyl-(2E)-2-[(2E)-1-(dicyanomethylene)-3-phenylprop-2-enyl]but-2-enedioate (68**).**

A solution of DMAD (170 mg, 1.2 mmol) and **67** (180 mg, 1 mmol) in dry DME (10 mL) under an argon atmosphere was cooled to $-10\text{ }^\circ\text{C}$. To this pyridine (16 mg, 0.2 mmol) was added and the reaction mixture was stirred for 3.5 h at room temperature. The solvent was then removed under vacuum and the residue on chromatographic separation on silica gel column using hexane-ethyl acetate mixture (95:5) gave the product, dimethyl-(2E)-2-[(2E)-1-(dicyanomethylene)-3-phenylprop-2-enyl]but-2-enedioate **68** as a colorless crystalline solid (45%).

Mp: 118-121 $^\circ\text{C}$.

IR (KBr) ν_{\max} : 3731, 3705, 2955, 2365, 2344, 2225, 1724, 1600, 1527, 1439, 1258, 1015 cm^{-1} .

$^1\text{H NMR}$: δ 7.55 (m, 2H), 7.46 (m, 4H), 7.30 (s, 1H), 6.93

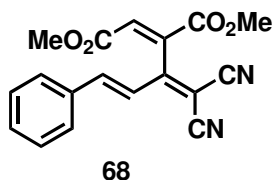

(d, $J = 15.8$ Hz, 1H), 3.89 (s, 3H), 3.79 (s, 3H).

^{13}C NMR: δ 164.9, 163.0, 162.7, 145.1, 138.2, 134.1, 131.8, 129.0, 128.2, 128.0, 122.6, 112.3, 111.6, 53.9, 52.8.

Anal Calcd. for $\text{C}_{18}\text{H}_{14}\text{N}_2\text{O}_4$: C, 67.07; H, 4.38; N, 8.69; Found; C, 67.23, H, 4.06; N, 8.76.

HRMS (EI) Calcd. for $\text{C}_{18}\text{H}_{14}\text{N}_2\text{O}_4$: 322.0954. Found: 322.0921.

[(2E)-2-benzoyl-1-(4-nitrophenyl)-4-oxo-4-phenylbut-2-enylidene]malononitrile (70).

A solution of DBA **69** (280 mg, 1.2 mmol) and **51** (199 mg, 1 mmol) in dry DME (10mL) under an argon atmosphere was cooled to -10 °C. To this pyridine (16 mg, 0.2 mmol) was added and the reaction mixture was stirred for 3.5 h at room temperature. The solvent was then removed under vacuum and the residue on chromatographic separation on silica gel column using hexane-ethyl acetate mixture (95:5) gave the product, [(2E)-2-benzoyl-1-(4-nitrophenyl)-4-oxo-4-phenylbut-2-enylidene]malononitrile **70** as a pale yellow liquid (23%).

IR (Neat) ν_{max} : 3107, 2977, 2232, 1746, 1670, 1665, 1567, 1478, 1245, 1001 cm^{-1} .

^1H NMR [300 MHz, $\text{CDCl}_3/\text{CCl}_4$, 7:3 (v/v)]: δ 8.01 (d, $J = 8.1$ Hz, 2H), 7.85 (d, $J = 8.0$ Hz, 2H), 7.3-7.8 (m 6H), 7.21 (d, $J = 7.8$ Hz, 2H), 7.02 (d, $J = 7.8$ Hz, 2H), 6.89 (s, 1H).

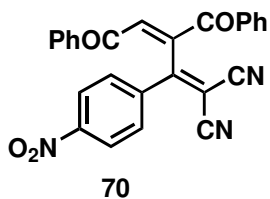

^{13}C NMR (75 MHz): δ 176.3, 173.5, 157.6, 140.1, 138.4, 135.8, 134.7, 133.9, 132.8, 131.8, 130.7, 130.1, 129.6, 129.4, 129.0, 128.7, 128.5, 127.6, 125.0, 119.4, 112.4, 112.2, 110.6, 103.2.

4.6 References

1. Winterfeldt, E. *Angew. Chem., Int. Ed. Engl.* **1967**, *6*, 424.
2. a) Johnson, A. W.; Tebby, J. C. *J. Chem. Soc.* **1961**, 2126. b) Tebby, J. C.; Wilson, I. F.; Griffiths, D. V. *J. Chem. Soc., Perkin Trans. 1* **1979**, 2133.
3. Winterfeldt, E.; Dillinger, H. J. *Chem. Ber.* **1966**, *99*, 1558.
4. Nozaki, K.; Sato, N.; Ikeda, K.; Takaya, H. *J. Org. Chem.* **1996**, *61*, 4516.
5. a) Nair, V.; Nair, J. S.; Vinod, A. U.; Rath, N. P. *J. Chem. Soc., Perkin Trans. 1* **1997**, 3129. b) Nair, V.; Nair, J. S.; Vinod, A. U. *Synthesis* **2000**, 1713.
6. a) Winterfeldt, E.; Schumann, D.; Dillinger, H. J. *Chem. Ber.* **1969**, *102*, 1656. b) Dillinger, H. J.; Fengler, G.; Schumann, D.; Winterfeldt, E. *Tetrahedron Lett.* **1974**, *15*, 2553.
7. Nair, V.; Vinod, A. U. *Chem. Commun.* **2000**, 1019.
8. Nair, V.; Vinod, A. U.; Rajesh, C. *J. Org. Chem.* **2001**, *66*, 4427
9. a) Nair, V.; Vinod, A. U.; Nair, J. S.; Sreekanth, A. R.; Rath, N. P. *Tetrahedron Lett.* **2000**, *41*, 6675.
10. Nair, V.; Vinod, A. U.; Abhilash, N.; Menon, R. S.; Santhi, V.; Varma, L. R.; Viji, S.; Mathew, S.; Sreenivas, R. *Tetrahedron* **2003**, *59*, 10279.
11. Hoffmann, R. W. *Angew. Chem., Int. Ed. Engl.* **1971**, *10*, 529.
12. Hoffmann, R. W.; Lilienblum, W.; Dittrich, B. *Chem. Ber.* **1974**, *107*, 3395
13. Warkentin, J. *J. Chem. Soc., Perkin Trans. 1* **2000**, 2161 and references cited therein.
14. a) Nair, V.; Bindu, S.; Balagopal, L. *Tetrahedron Lett.* **2001**, *42*, 2043. b) Nair, V.; Bindu, S.; Sreekumar, V.; Balagopal, L. *Synthesis* **2003**, 1446.
15. Arduengo, A. J., III; Harlow, R. L.; Kline, M.K. *J. Am. Chem. Soc.* **1991**, *113*, 9704.
16. Nair, V.; Bindu, S.; Sreekumar, V.; Rath, N. P. *Org. Lett.* **2003**, *5*, 665.
17. Diels, O.; Alder, K. *Liebigs Ann. Chem.* **1932**, *16*, 498.

-
18. a) Acheson, R. M.; Plunkett, A. O. *J. Chem. Soc., Perkin Trans. I* **1975**, 438. b) Acheson, R. M.; Taylor, G. A. *Proc. Chem. Soc.* **1958**, 186. c) Acheson, R. M.; Taylor, G. A. *J. Chem. Soc.* **1960**, 1691. d) Acheson, R. M.; Gagan, J. M. F.; Taylor, G. A. *J. Chem. Soc.* **1963**, 1903.
19. a) Acheson, R. M.; Plunkett, A. O. *J. Chem. Soc.* **1964**, 2676. b) Crabtree, A.; Johnson, A. W.; Tebby, J. C. *J. Chem. Soc.* **1961**, 3497.
20. Acheson, R. M. *Adv. Heterocycl. Chem.* **1963**, *1*, 125.
21. Winterfeldt, E.; Naumann, A. *Chem. Ber.* **1965**, *98*, 3537.
22. Acheson, R. M.; Hodgson, S. J.; Wright, R. G. M. *J. Chem. Soc., Perkin Trans. I* **1976**, 1911.
23. Huisgen, R.; Morikawa, M.; Herbig, K.; Brunn, E. *Chem. Ber.* **1967**, *100*, 1094.
24. a) Nair, V.; Sreekanth, A. R.; Vinod, A. U. *Org. Lett.* **2001**, *3*, 3495. b) Nair, V.; Sreekanth, A. R.; Vinod, A. U. *Org. Lett.* **2002**, *4*, 2807. c) Nair, V.; Sreekanth, A. R.; Abhilash, N.; Biju, A. T.; Devi, B. R.; Menon, R. S.; Rath, N. P.; Srinivas, R. *Synthesis* **2003**, 1895.
25. Nair, V.; Pillai, A. N.; Menon, R. S.; Suresh, E. *Org. Lett.* **2005**, *6*, 1189.

SUMMARY

The thesis entitled “**NOVEL HETEROCYCLIC CONSTRUCTIONS MEDIATED BY 1,4-DIPOLAR INTERMEDIATES AND RELATED CHEMISTRY**” embodies the results of our investigations carried out to explore the reactivity patterns of Huisgen 1,4-dipoles, generated *in situ* from Dimethyl Acetylenedicarboxylate (DMAD) and various nitrogen containing heterocyclic compounds.

A general introduction to Huisgen 1,4-dipolar cycloaddition reactions is presented in chapter 1. A definition of the present work is also incorporated in this chapter.

The second chapter describes the reactivity of 1,4-dipolar intermediate generated from isoquinoline and DMAD with various activated styrenes. It was found that the *in situ* generated 1:1 intermediate undergoes a facile addition with arylidene malononitrile to afford the diastereomeric mixture of tetrahydrobenzoquinolizine derivatives (Scheme 1).

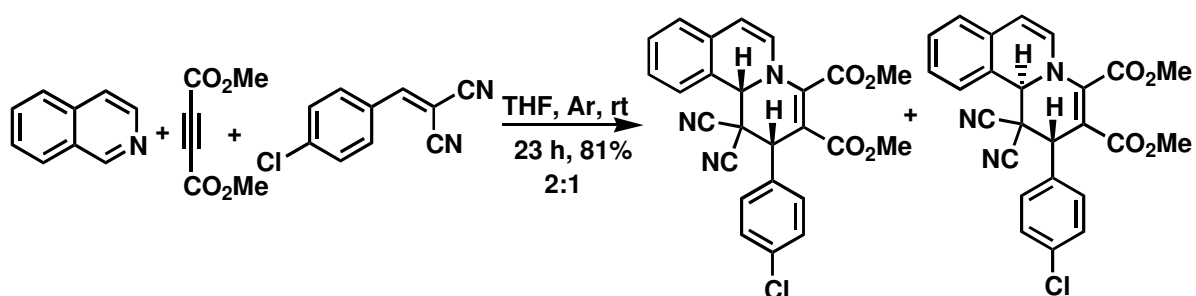

Scheme 1

Similar reactivity was observed with arylcyanoacrylates, yielding the product in moderate yields. When the zwitterion generated from isoquinoline and

DMAD was treated with isatilidene derivatives, it afforded the expected oxindolinylidene derivatives (Scheme 2).

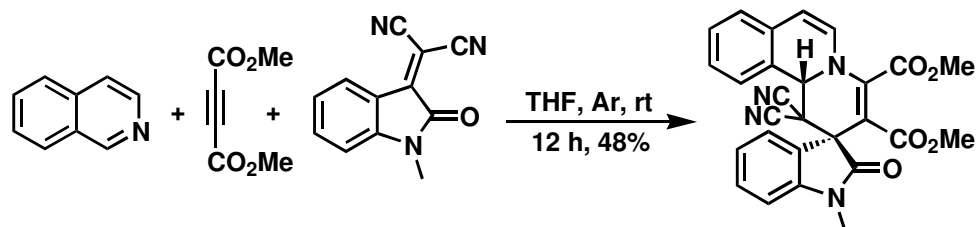

Scheme 2

In the third chapter, the interception of the 1:1 zwitterionic intermediate, generated *in situ* from benzothiazole and DMAD with activated styrenes, leading to the facile synthesis of pyridobenzothiazole derivatives is described (Scheme 3).

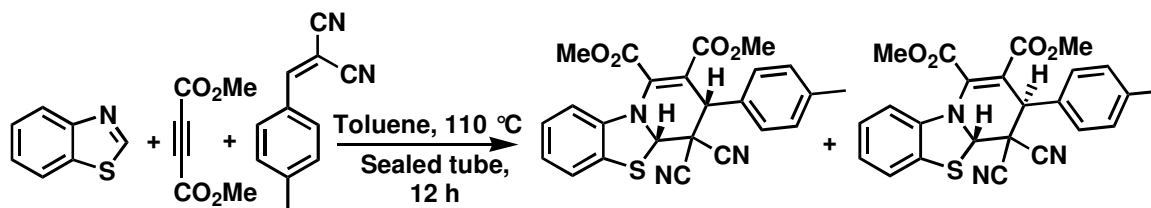

Scheme 3

The fourth chapter contains the results of investigations aimed at studying the pyridine catalyzed reaction of DMAD with activated styrenes. This reaction led to the facile synthesis of highly substituted *trans* 1,3-butadiene derivatives (Scheme 4).

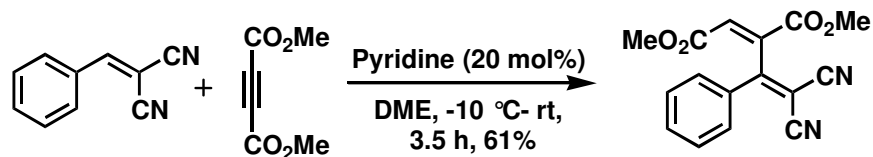

Scheme 4

In conclusion, we have developed a novel and efficient one pot reaction of isoquinoline and DMAD with various dipolarophiles such as activated styrenes and isatylidene derivatives leading to the formation of various polycyclic compounds. Also we have observed a novel three component condensation reaction that offers an easy and one-pot entry to the synthesis of various pyrido benzothiazole derivatives *via* the 1,4-dipolar cycloaddition reactions of the zwitterions generated from benzothiazole and DMAD with activated styrenes. We have demonstrated an efficient and simple protocol for the synthesis of highly substituted *trans* 1,3-butadiene derivatives by pyridine catalyzed reactions of DMAD and electrophilic styrenes. It is conceivable that the novel reactions described herein will find application in the synthesis of a variety of heterocyclic compounds.

LIST OF PUBLICATIONS

- 1) A Novel Multicomponent Protocol for the Synthesis of Oxazinobenzothiazole Derivatives. Nair, V.; Abhilash, N.; **Devi, B. R.**; Suresh, E. *Tetrahedron Lett.* **2007**, *48*, 4391.
- 2) The Huisgen 1,4-Dipolar Cycloaddition Involving Isoquinoline, Dimethyl butynedioate and Activated Styrenes: A Facile Synthesis of Tetrahydrobenzoquinolizine Derivatives. Nair, V.; **Devi, B. R.**; Varma, R. L. *Tetrahedron Lett.* **2005**, *46*, 3333.
- 3) Novel Pyridine Catalyzed Reaction of Dimethyl Acetylenedicarboxylate (DMAD) and Arylidenemalonitriles: A Stereoselective Synthesis of Highly Substituted Buta-1,3-dienes. Nair, V.; **Devi, B. R.**; Vidya, N.; Abhilash, N.; Menon, R. S. *Tetrahedron Lett.* **2004**, *45*, 3203.
- 4) Novel One-pot Four-component Reaction of Isocyanides, Dimethyl Acetylenedicarboxylate and Cyclobutene-1,2-diones: Synthesis of Novel Spiroheterocycle. Nair, V.; Menon, R. S.; Deepthi, A.; **Devi, B. R.** *Tetrahedron Lett.* **2004**, *45*, 1337.
- 5) Pyridine Catalyzed Reaction of Dimethyl Acetylenedicarboxylate with Carbonyl Compounds and *N*-Tosylimines: Efficient Synthesis of 2-Benzoyl fumarates and 1-Azadienes. Nair, V.; Sreekanth, A. R.; Abhilash, N.; Biju, A. T.; **Devi, B. R.**; Menon, R. S.; Rath, N. P.; Sreenivas, R. *Synthesis* **2003**, 1895.
- 6) A Facile Synthesis of Thiaaza-and Thiadiaza-fluorene Derivatives Involving Benzothiazole-DMAD Zwitterion with Arylidenemalonitriles and *N*-Tosylimines. Nair, V.; **Devi, B. R.**; Paul, R. R.; Pillai, A. N. (Accepted *Heterocycles* **2007**).
- 7) Novel Multicomponent Reaction Involving Isoquinoline, Dimethyl Acetylenedicarboxylate and Isatilidenes: A Novel Protocol for the Synthesis of Functionalized Spiro-Oxindoles. Nair, V.; **Devi, B. R.** (to be communicated).

POSTERS PRESENTED

- 1) Organocatalytic Synthesis of Highly Substituted Butadienes: Nair, V.; **Rema Devi, B.**; Menon, R. S. Seventh National Symposium in Chemistry; Kolkatha, February, **2005**, Poster # 114.
- 2) The Huisgen 1,4-Dipolar Cycloaddition Involving Isoquinoline, Dimethyl butynedioate and Activated Styrenes: Nair, V.; **Rema Devi, B.**; Menon, R. S. International Symposium on Advances in Organic Chemistry-INSOC; Kottayam, January, **2006**, Poster # 77.
- 3) New Synthetic Transformations Involving Zwitterions Derived from *N*-Heterocycles and Activated Acetylenes. Nair, V.; Pillai, A. N.; **Rema Devi, B.**; Beneesh P. B.; Abhilash K. G. Eighth CRSI National Symposium in Chemistry; Mumbai, February, **2006**, Poster # 80.
- 4) The Huisgen 1,4-Dipolar Cycloaddition Involving *N*-Heterocycles, Dimethyl Acetylenedicarboxylate and Isatilidenes Leading to the Synthesis of Funtionalized Spiro-Oxindoles. Nair, V.; **Rema Devi, B.** 3rd International Symposium on Current Trends in Drug Discovery Research, CDRI, Lucknow, February **2007**, Poster # 78.